

# ELEKTOR ELECTRONICS

FEBRUARY 2004  
£3.70

THE ELECTRONICS & COMPUTER MAGAZINE

[www.elektor-electronics.co.uk](http://www.elektor-electronics.co.uk)

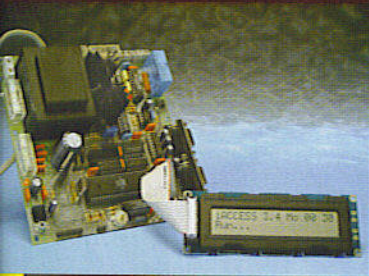

**iButton Access  
Control System**



**Simple  
12-to-230 V  
Power Inverter**

**Electronic Valentine  
Heart**

**Digital Alarm Clock**

**DIY RF Inductors x100**

**Touch-Controlled  
Switch**

# HANDS-ON CPLDs

**complex logic  
for your own  
designs**

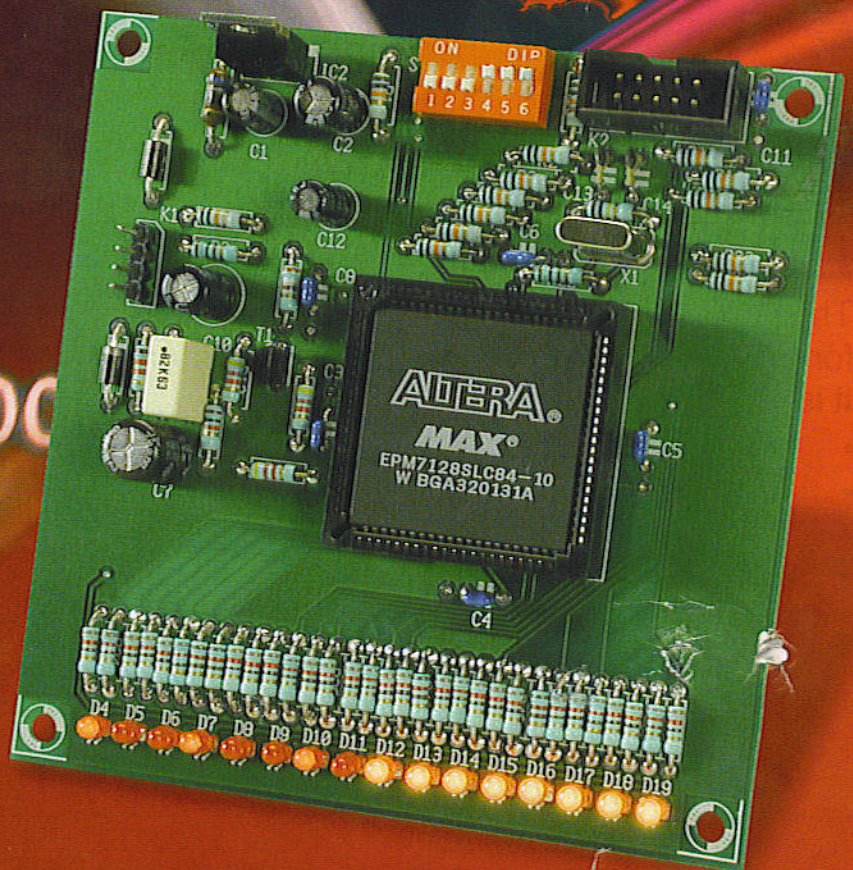

9 770268 451111

# PAGM

The leaders in PIC development

**FROM**

**£99**

- ◆ All you need to get started with PIC
- ◆ Industry standard/quality board
- ◆ Open the box and get coding
- ◆ Available with C compiler or use our PicScript to write programs using simple commands...

**NO ASSEMBLER,  
NO COMPILER,  
JUST WRITE AND RUN**



**EASE OF USE**

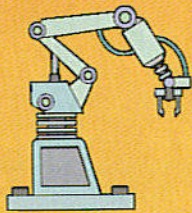

**AUTOMATION**

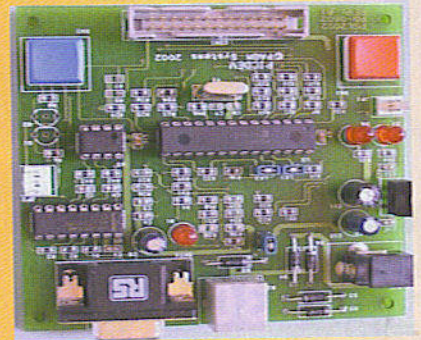

**SCRIPTABILITY**

PicDev Board with PicScript

**£99.00** (plus p+p)

This is a complete development suite for the novice or non programmer.

It is shipped with:

- PicDev Board
- PicShell and PicScript software
- Breakout board
- Cables
- Example scripts

PicDev Board with C Compiler

**£165.00** (plus p+p)

This is a complete development suite for the more advanced programmer.

It is shipped with:

- PicDev Board
- PicShell and PicScript software
- C compiler
- Breakout board
- Cables
- Example scripts
- ICD1

Both items require

- PC with serial port available
- Power supply adapter

**To order:**

[www.pagm.co.uk](http://www.pagm.co.uk)

[sales@pagm.co.uk](mailto:sales@pagm.co.uk)

Tel: +44 (0)1792 891927



# PICK YOUR OWN SUBSCRIPTION TYPE AND RECEIVE THIS SURVIVAL KIT<sup>1</sup>

*This survival kit consists of a collapsible compass with various functions, a lightweight but robust torchlight (batteries included) and a 9-piece stainless steel pair of pliers with 14 functions.*



The choice is yours!  
Fill out the Subscription  
Order Form in this maga-  
zine or on our website  
and post it today!  
Your welcome gift will be  
sent to you as soon as  
possible after receipt of  
your subscription pay-  
ment.

The Volume 2003 CD-ROM is  
automatically sent to you when  
published (February 2004)

**If you take out an  
annual subscription  
to ELEKTOR ELEC-  
TRONICS you may  
choose between  
two types of sub-  
scription.**

- 1 Elektor Electronics Subscription-PLUS priced at £45.50 (UK).**  
You receive 11 issues (includes July/August double issue) **plus a copy of the Volume 2003 CD-ROM.** This CD-ROM contains the complete Volume 2003 of Elektor Electronics, including **diagrams, PCB layouts and an extensive search function.**  
The normal price is £16.25 (plus P&P). However on choosing Subscription Plus the Volume 2003 CD-ROM is included in the price, and you do not pay postage.  
**Your saving: £10.00!**
- 2 Elektor Electronics annual subscription priced at £39.50 (UK).**  
You receive 11 issues (includes July/August double issue).

A standard annual subscription costs £39.50 in the United Kingdom; ECONOMY MAIL: £51.30 in the rest of the world; PRIORITY AIRMAIL: £52.30 in Europe and Eire, £64.00 in the Middle East, Africa, Southwest Asia, Central & South America, £66.00 in Australia, Far East & Pacific Territories; AIRFREIGHT: US\$88.00 in USA & Canada only.  
Subscription-PLUS prices may be found on the reverse of the Subscription Order form, and on our website.

[www.elektor-electronics.co.uk](http://www.elektor-electronics.co.uk)

**ELEKTOR  
ELECTRONICS**  
THE ELECTRONICS & COMPUTER MAGAZINE

<sup>1</sup> Only applicable if the new subscriber did not subscribe to Elektor Electronics in the past 12 months.  
Offer subject to availability.

Produced and published by  
Elektor Electronics (Publishing), P.O. Box 190,  
Tunbridge Wells TN5 7WY, England.  
Telephone: (+44) (0)1580 200657, Fax: (+44) (0)1580 200616  
Internet: www.elektor-electronics.co.uk  
Email: sales@elektor-electronics.co.uk

Editor: Jan Buiting  
Email: editors@elektor-electronics.co.uk

Laboratory Staff: Karel Walraven, Ton Giesberts, Paul Goossens,  
Luc Lemmens, Peter Verhoosel (PCB design)  
Email: techdept@segment.nl  
International Secretariat: Hedwig Hennekers, Marion Jeunhomme  
Email: secretariat@segment.nl

Publisher: Pierre Kersemakers  
Email: p.kersemakers@segment.nl

UK Advertising  
Bernard Hubbard, 3 Crescent Terrace,  
Cheltenham GL50 3PE, England.  
Telephone (+44) (0)1242 510760, Fax: (+44) (0)1242 226626  
Email: bernardhubbard@ukonline.co.uk  
Advertising rates and terms available on request.

International Advertising  
K. Caldenhoven, address as Head Office  
Email: advertentbes@elektuur.nl  
Advertising rates and terms available on request.

Subscriptions  
Worldwide Subscription Service Ltd., Unit 4,  
Gibbs Reed Farm, Pashley Road, Ticehurst TN5 7HE, England.  
Telephone: (+44) (0)1580 200657, Fax: (+44) (0)1580 200616  
Email: wvss@wvss.demon.co.uk  
Rates and terms are given on the Subscription Order Form

Head Office  
Segment b.v.  
P.O. Box 75 NL-6190-AB Beek The Netherlands  
Telephone: (+31) 46 4389444, Fax: (+31) 46 4370161

Distribution  
Seymour, 86 Newman Street, London W1P 3LD, England

Copyright notice  
The circuits described in this magazine are for domestic use only. All drawings, photographs, printed circuit board layouts and article texts published in the editorial section of the magazine are copyright Segment b.v. and may not be reproduced or transmitted in any form or by any means, including photocopying, scanning or recording, in whole or in part without prior written permission from the Publishers. Such written permission must also be obtained before any part of this publication is stored in a retrieval system of any nature. Patent protection may exist in respect of circuits, devices, components etc. described in this magazine. The Publisher does not accept responsibility for failing to identify such patent(s) or other protection. The submission of designs or articles implies permission to the Publishers to alter the text and design, and to use the contents in other Segment publications and activities. The Publishers cannot guarantee to return any material submitted to them.

Technical Queries  
We can only answer questions or remarks of general interest to our readers, concerning projects not older than two years and published in Elektor Electronics. In view of the amount of post received, it is not possible to answer all correspondence, and we are unable to respond to individual wishes and requests for modifications to, or additional information about, Elektor Electronics projects. To find article titles and issue/page references, please use our EIT (Elektor Item Tracer) which is available on floppy disk (see Readers Services). We do not supply kits for the projects described in this magazine. Our supply range is limited to PCBs, CD-ROMs, diskettes, programmed microcontrollers, GALs, PALs, FPGAs and EPROMs. All other parts for building our projects should be purchased from kit/component suppliers advertising in this magazine.

Overseas Editions  
Elektor is also published in The Netherlands, Germany, France. Franciseditions appear in Sweden, Finland, Greece, India, Poland, Portugal and Spain. Please contact Head Office for address information.

© Segment b.v. 2004  
Printed in the Netherlands

Elektor Electronics is published monthly, except in August. The magazine is available from newsagents, bookshops and electronics retail outlets, or on subscription.

## CONSTRUCTION PROJECTS

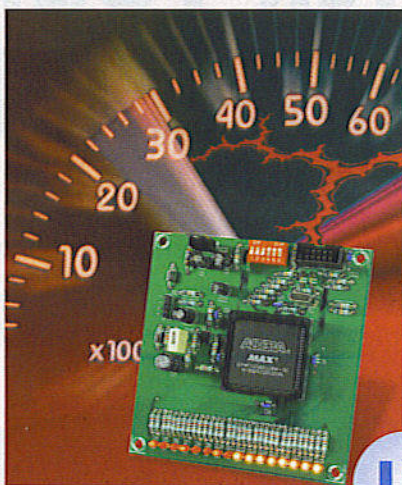

12

### Hands-On CPLDs

In the past Complex Programmable Logic Devices (CPLDs) have been something of a closed book to most semi-professional electronics enthusiasts but this hands-on series should go some way to help dispel that myth.

### Digital Alarm Clock

Although digital alarm clocks have been around for years, most of today's off the shelf products suffer from serious design limitations. For example, many don't keep track of weekdays and can only store one alarm time. High time for a home-brew design that does a better job.

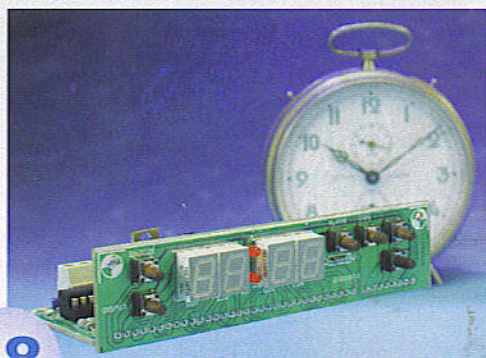

18

### Simple 12-to-230 V Power Inverter

In some cases, mains power can only be brought to a remote site by running a very long cable — which is either dangerous, impossible or not available. Whatever the occasion, planned or unexpected, it is great to have a power inverter available capable of changing the 12-V car battery voltage into 230 volts AC.

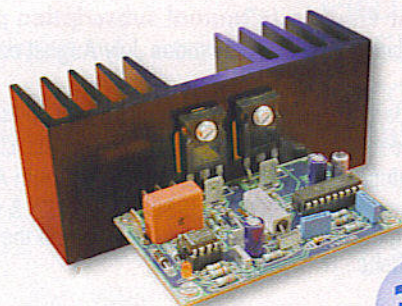

30

## iAccess

The system described here goes further than most ordinary protection systems for home and property. Besides granting persons selective access to specific areas, iAccess allows you to check who was granted access to which area and when.

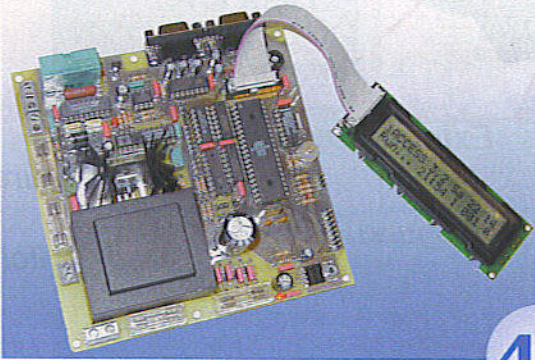

42

## INFORMATIVE ARTICLES

### 24 DIY RF Inductors

Electronics hobbyists often wish to copy a circuit for which suitable coils or fixed inductors are not readily available. However, you can wind just about any type of inductor if you only know how. Or you can take inductors from old equipment and modify or adjust them. All you have to do is determine is how many turns you need.

### CoolRunner-II

Here's a brief article about an attractive development kit from our friends at Xilinx, which is

not only rich in contents but also affordable for the hobbyist!

The board is supplied ready-built and comes with two CD-ROMs crammed with software.



52

## Construction Projects

- 12 Hands-On CPLDs
- 18 Digital Alarm Clock
- 30 Simple 12-to-230 V Power Inverter
- 36 Touch-controlled Switch
- 38 Parallel Port Switching Interface
- 42 iAccess
- 56 Electronic Valentine Heart

## Informative Articles

- 24 DIY RF Inductors
- 35 Foil Capacitor Polarity
- 52 CoolRunner-II
- 64 Remote Control for your PC

## Regulars

- 11 News
- 41 Corrections & Updates
- 51 Electrical Safety
- 55 New Products
- 59 New Products
- 67 Readers Services
- 74 Sneak Preview
- 74 Index of Advertisers

# DrDAQ Data Logger

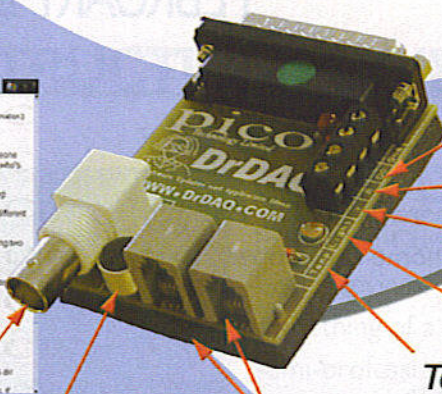
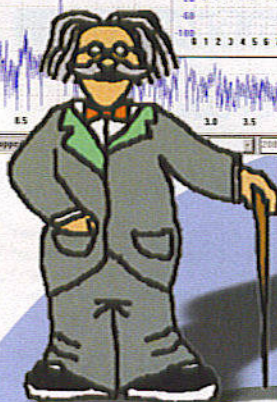
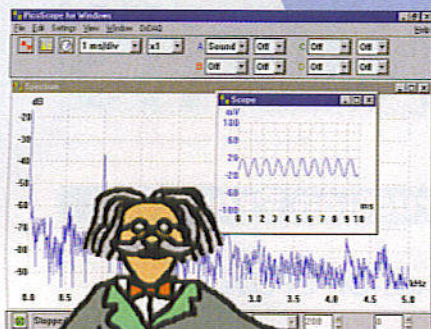

- Output
- Resistance
- Voltage
- Light level
- Temperature
- pH
- Microphone

External sensors: Humidity  
Temperature  
O2 In Air  
Reed Switch

- Low cost- under £60
- Built in sensors for light, temperature and sound (level and waveforms)
- Use DrDAQ to capture fast signals
- Outputs for control experiments
- Supplied with both PicoScope (oscilloscope) and PicoLog (data logging) software

For more information on DrDAQ, please visit:

[www.picotech.com/drdaq85](http://www.picotech.com/drdaq85)

# PC Oscilloscopes

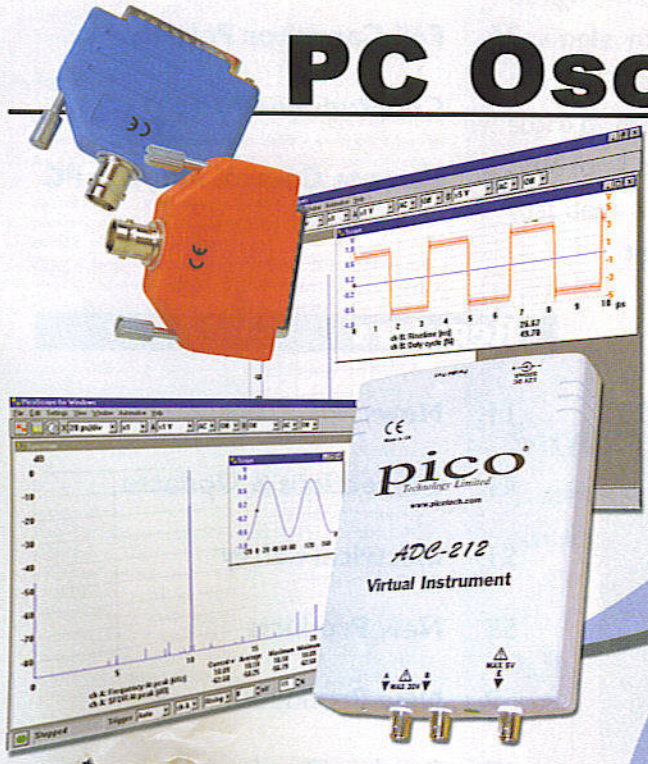

- Scope and spectrum analyser functions
- A fraction of the cost of benchtop scope
- Save multiple setups, for ease of use
- Save, print and e-mail your traces
- FREE technical support for life
- FREE software and upgrades
- Automated measurements

For more information on our scopes, please visit:

[www.picotech.com/scope153](http://www.picotech.com/scope153)

Tel: 01480 396395 Fax: 01480 396296 E-mail: [sales@picotech.com](mailto:sales@picotech.com)

PICO Technology Limited

# FLOWCODE



Allows users with no programming skills to design complex electronic systems

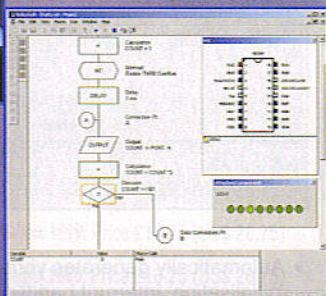

Flowcode is a programming system for PICmicro microcontrollers based on flowcharts. Flowcode includes macros to facilitate the control of complex devices like 7-segment and LCD displays. Flowcode allows complete novices to design control systems without getting bogged down in the programming involved.

- Requires no programming experience
- Full on screen simulation
- Produces PICmicro hex code for a range of 8, 18, 28, and 40 pin devices
- Full suite of demonstration tutorials
- Allows complex PICmicro designs to be produced in minutes

for full specification see:

[www.matrixmultimedia.co.uk](http://www.matrixmultimedia.co.uk)

or contact us for a full colour brochure

email: [sales@matrixmultimedia.co.uk](mailto:sales@matrixmultimedia.co.uk)  
tel: 0870 700 1831 fax: 0870 700 1832

**matrix**  
multimedia

## PICmicro<sup>®</sup> microcontroller development board

The World's most advanced solution for learning and programming PICmicro microcontrollers

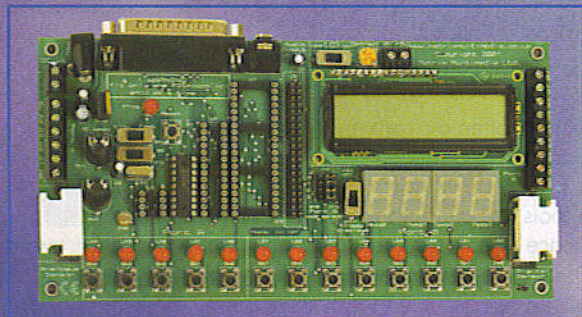

- Allows you to program PICmicros and test your programs
- Designed for education, hobbyists and industry
- Supports low cost Flash programmable PICmicro devices
- Fully featured displays including 2 line LCD and quad 7-segment LED
- Programs most 8, 18, 28, 40 pin devices - including those with ADC capabilities
- Free download software provides seamless send and verify function
- 3 CD ROM courses in C, assembly code, and flowchart programming are available

for full specification see:

[www.matrixmultimedia.co.uk](http://www.matrixmultimedia.co.uk)

or contact us for a full colour brochure

email: [sales@matrixmultimedia.co.uk](mailto:sales@matrixmultimedia.co.uk)  
tel: 0870 700 1831 fax: 0870 700 1832

**matrix**  
multimedia

A QUANTUM LEAP IN  
EMBEDDED CONTROLLERS

# Quick FIRE SUPERCONTROLLERS

Our range provides:-

- The fastest 68000 based Core up to 66 Mhz.
- Extensive I/O:- Serial, IrDA, SPI, I<sup>2</sup>C, Analogue, Timers/Counters, RTC, etc.
- Large Memory Capacity:- Flash, SRAM, DRAM.
- Supports:- Mono & Colour LCD's, Touch Panels & Keypads, Very Low Power.

**ALSO LOW COST**

## DEVELOPMENT

- Target easily & quickly.
- Full ANSI 'C' compiler, assembler & linker all Windows32 based.
- Source Level Debug.
- Full Driver Support with Libraries.
- Real Time Multitasking OS with a free run time licence.
- FREE Unlimited email support.

[www.cms.uk.com](http://www.cms.uk.com)

see our web site for full details

CAMBRIDGE MICROPROCESSOR SYSTEMS LTD



Unit 17-18 Zone 'D' Chelmsford Rd. Ind. Est.  
Great Dunmow, Essex CM6 1XG

Telephone: **01371 875644**  
email: [sales@cms.uk.com](mailto:sales@cms.uk.com)

# Forest Electronics – PIC and AVR ANSI C Compiler Products

FED's ANSI C Compiler for PIC or AVR processors

- Fully integrated editor with syntax highlighting, multiple pages etc.
- Full project support - include and manage multiple source files, simulator, assembler files and notes/comments within one project
- Fully integrated simulator and waveform analyser step from C line to C line, or examine code in assembler form. View device pins using a logic analyser application.
- Simulator supports LCD modules, keypad, buttons, LED's, displays, analogue inputs, serial and asynchronous data.
- Designed to ANSI C standards
- PIC - Supports 18xxx, 16xxx, 12xxx series 14 and 16 bit core processors
- AVR - Supports standard and MEGA core processors
- Generates MPLAB/AVR Studio projects and source files and completely standard hex output files.

Prices from £45.00 – [www.fored.co.uk](http://www.fored.co.uk) for full details.

## WIZ-C / AVIDICY

**Drag and Drop rapid application development using ANSI C for PIC and AVR**

- Rapid Application Development for the PIC or AVR microcontroller using the C language (WIZ- C for the PIC, AVIDICY for the AVR)
- Drag and drop your software component selections on to your design
- Included components support timers, serial interfaces, I2C, LCD, 7 Seg displays, keypads, switches, port controls, many bus interfaces including IIC and Dallas iButton, AVR/PIC Hardware, and more.
- Connect software components to MCU pins by point & click
- Parameters set from drop down list boxes, check boxes, or text entry
- Links your code automatically into library events (e.g. Button Pressed, Byte Received etc.)

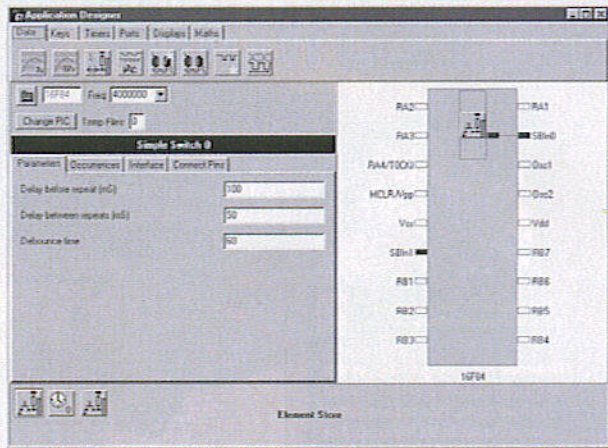

- Automatically generates your base application including full initialisation, interrupt handling and main program loop
- The complete C Compiler and AVR Simulator programs are integrated into AVIDICY - total editing / compilation / assembly / simulation support in one program
- Also includes the Element Editor to enable you to create your own components with ease.
- Demonstration available from our web site

Prices from £50.00 - full details from [www.fored.co.uk](http://www.fored.co.uk)



## Forest Electronic Developments

12 Buldowne Walk, Sway  
LYMINGTON, Hampshire, SO41 6DU.  
01590-681511 (Voice/Fax)

Email –  
"info@fored.co.uk"



**Full details from - [www.fored.co.uk](http://www.fored.co.uk)**

## SOFTWARE TOOLBOX

### VOLUME 2

**NEW**



£12.05 (US\$ 21.25)  
ISBN 90-5381-171-1

The second Toolbox CD-ROM again contains a vast collection of carefully selected software tools for the electronics enthusiast.

In your profession or hobby, how often did you experience that your project failed to reach the target in time because essential information was missing? Toolbox 2 offers new inroads to obtain information you just can't do without. This new CD-ROM contains software tools for, and information about, microcontrollers. However, just being aware of the existence of a microcontroller is often not sufficient – available data often needs to be extended with facts and figures about the right memory devices and communication channels.

That's why this CD-ROM gives specific attention to technical documentation (specifications, application notes, standards) about protocols (DiSEqC – Digital Satellite Equipment Control), field buses (including LON and HART), as well as modern information carriers (Smart Media, CompactFlash, SD card, etc.) which find increasing use. The hardware side of things is not forgotten either – Toolbox 2 contains data on connectors, cables and adapters (audio/video, GSM, memory, networks, parallel, serial, keyboard/mouse).

The CD-ROM also contains a large number of useful Internet addresses.

Order now using the Order Form in the Readers Services section in this issue

Elektor Electronics (Publishing) • P.O. Box 190 • Tunbridge Wells TN5 7WY  
• England. Telephone +44 (0) 1580 200 657 • Fax +44 (0) 1580 200 616

**ELEKTOR  
ELECTRONICS**  
THE ELECTRONICS & COMPUTER MAGAZINE

See also  
[www.elektor-electronics.co.uk](http://www.elektor-electronics.co.uk)



# CD-ROMS FROM ELEKTOR ELECTRONICS



## CD Elektor

On each CD you will find all articles published in the relevant year, incl. circuit diagrams and PCB layouts, and an extensive search program. The 1997 and 1998 CD-ROMs also include a working demo of Electronics Workbench for computer simulation of selected Elektor projects.

**CD Elektor 1996:** Price £25.35 (US\$ 44.85)

**CD Elektor 1997:** Price £25.35 (US\$ 44.85)

**CD Elektor 1998:** Price £16.25 (US\$ 28.75)

**CD Elektor 1999:** Price £16.25 (US\$ 28.75)

**CD Elektor 2000:** Price £16.25 (US\$ 28.75)

**CD Elektor 2001:** Price £16.25 (US\$ 28.75)

**CD Elektor 2002:** Price £16.25 (US\$ 28.75)



## pP-PC hardware & software 97-98

All the winning entries of the July/August 1997 microprocessor competition: more than 100 designs  
RRP £14.95 (US\$ 26.45)

## PC Software 98-99

Winning entries from the July/August 1998 PC software competition. More than 70 prize-winning programs (DOS and Windows).  
RRP £12.05 (US\$ 21.25)

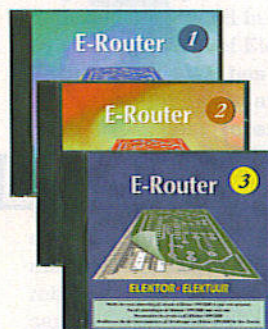

## E-Router 1, 2 & 3

**Vol. 1:** 22 Elektor Electronics projects covering microprocessors, complete with text, circuit diagrams and PCB layouts in electronic format.  
RRP £21.15 (US\$ 37.40)

**Vol. 2:** 19 microprocessor-based construction projects, complete with text, circuit diagrams and PCB layouts in electronic format.  
RRP £21.15 (US\$ 37.40)

**Vol. 3:** 24 pP projects incl. text, PCB layouts and schematics in separate files for editing with EAGLE 3.5 CAD software. Selected projects supplied with microcontroller source code files.  
RRP £21.15 (US\$ 37.40)

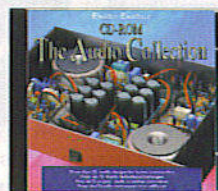

## The Audio Collection CD-ROM

A unique CD-ROM for the true audio lover, containing no fewer than 75 audio designs from Elektor Electronics magazine year volumes 1995 through 1999.  
RRP £12.05 (US\$ 21.25)



## Elektor IC databank

Includes all important types of IC, such as HCMOS, TTL, CMOS, linear ICs, and many more. Detailed manufacturers' data and application circuits. Multiple search routines.  
RRP £21.15 (US\$ 37.40)



## ECD - Elektor's Component Database

Four interactive databanks covering over 5,300 ICs, over 22,500 bipolar transistors, over 4,900 FETs, just under 25,000 diodes, over 1,800 optocouplers, thyristors and triacs. Plus 9 calculation tools for zener diode series resistors, voltage regulators, voltage dividers, AMV's, resistor and inductor values.  
RRP £12.95 (US\$22.90)

## Elektor Electronics Digital Circuit Library (1-2-3)

### On volume 1

Contains over 300 circuits complete with diagram and text. Zoom and print module. Fast search facility. Error-tolerant index search system. Many printed-circuit board layouts.  
RRP £12.05 (US\$ 21.25)

### On volume 2

A second selection of over 300 circuits complete with diagram and text.  
RRP £12.05 (US\$ 21.25)

### On volume 3

A third selection of over 300 circuits complete with diagram and text.  
RRP £12.05 (US\$ 21.25)

## The Elektor Datasheet Collection,

### On Volume 1:

Original and unabridged datasheets, more than 300 ICs (74xx and 40x series), voltage regulators, linear ICs, miscellaneous.  
RRP £12.05 (US\$ 21.25)

### On Volume 2:

Datasheets of more than 1000 discrete components: low/high-power transistors, MOSFETs, thyristors, triacs, varactors, zener diodes, LED displays, etc.  
RRP £12.05 (US\$ 21.25)

### On Volume 3:

Datasheets of popular microcontrollers like the 8051 series, PIC, ST67, AVR, COP, 68HC05/08/11 and SX. Also the DSP2100 series.  
RRP £12.05 (US\$ 21.25)

### On Volume 4:

Datasheets of frequently used memory chips and modules.  
RRP £12.05 (US\$ 21.25)

### On Volume 5:

More than 400 datasheets covering microcontrollers from 4 to 32 bit, in 8-pin to 144 pin cases.  
RRP £12.05 (US\$ 21.25)

All Datasheet CD-ROMs are suitable for PC/Windows and Macintosh computers.

## Free & Shareware 2000-2003

This series contains hundreds of freeware and shareware programs related to electronics. Interest fields include audio, components, test and measurement, development tools, simulation, CAD and RF systems. Applications vary from schematic capture including digital and analogue simulation right up to PCB design, complete with calculation tools and microcontroller development tools. Depending on their origins the programs run under Windows, DOS and/or Linux. Each CD-ROM (except Volume 2000) contains a PDF file with a clear overview of programs on the CD-ROM.  
RRP £12.05 (US\$ 21.25) per volume

## Toolbox 1 and 2

On these CD-ROMs you'll find collected information (datasheets and application notes) and tools (software) considered indispensable when working with microcontrollers.  
RRP £12.05 (US\$ 21.25) per volume

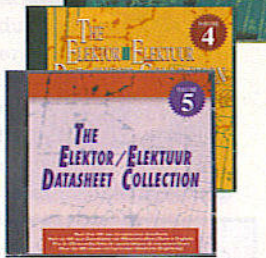

Order now using the Order Form in the Readers Services section in this issue

Elektor Electronics (Publishing) • P.O. Box 190 • Tunbridge Wells  
TN5 7WY • England. Telephone +44 (0) 1580 200 657 • Fax +44  
(0) 1580 200 616

**ELEKTOR  
ELECTRONICS**  
THE ELECTRONICS & COMPUTER MAGAZINE

See also  
[www.elektor-electronics.co.uk](http://www.elektor-electronics.co.uk)

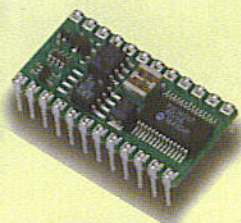

BS2-IC

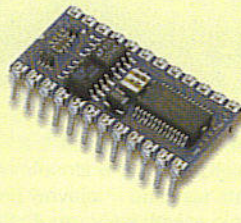

BS2-SX

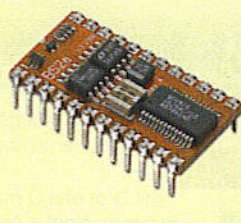

BS2E-IC

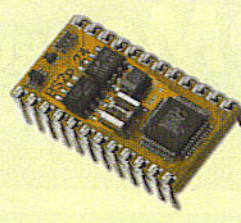

BS2P/24

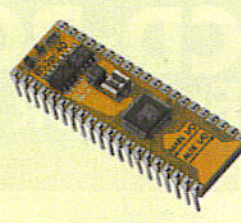

BS2P/40

**Parallax BASIC Stamps - still the easy way to get your project up and running!**

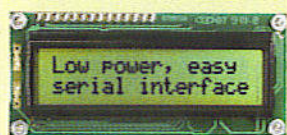

**Serial Alphanumeric and Graphic Displays, Mini-Terminals and Bezel kits**

# www.milinst.com



Animated Head

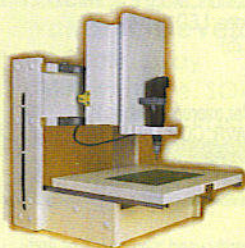

3-Axis Machine



Six-Legged Walkers

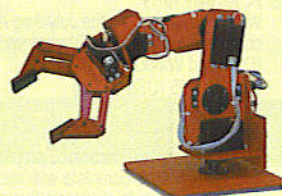

Robotic Arms



Bipeds

**Robotic models for both the beginner and the advanced hobbyist**

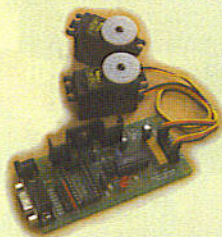

Servo Drivers

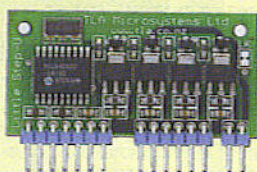

Motor Drivers

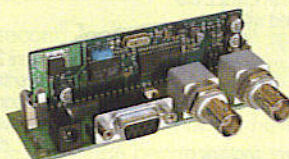

On-Screen Displays



DMX Protocol

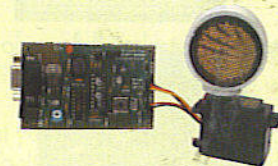

U/Sound Ranging

**Animatronics and Specialist Interface-Control Modules**

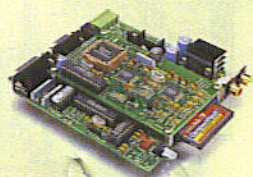

Quadravox MP3 & Speech Systems



SensoryInc Voice Recognition



Parallax Ubicom Tool Kits



Tech-Tools PIC & Rom Emulators

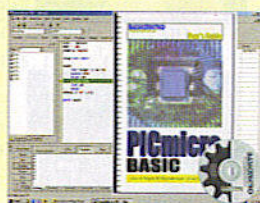

BASICMicro PIC BASIC Compilers

**Development Tools**

Milford Instruments Limited Tel 01977 683665, Fax 01977 681465, sales@milinst.com

## Birmingham's TIC to host international Micro-Robotics Competition

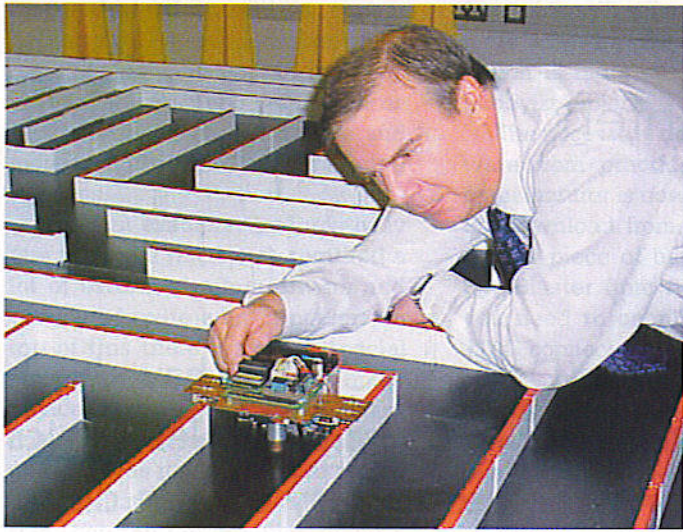

MICROMOUSE 2004 is the latest event in the world's longest running robotics competition. Originated in the UK by the Institution of Electrical Engineers (IEE), it has run for more than 20 years and has been held most recently at Royal Holloway College, University of London.

The event consists of races against the clock between microprocessor controlled robotic 'mice' programmed to search and solve complex mazes. The fastest 'micromouse' wins.

There are several technical standards in the competition, with senior and junior categories. This enables individuals and organisations at different levels of technical skill to enter. Individuals, clubs, companies, schools, colleges and universities have all competed in past competitions.

The design and construction of these robotic mice is often an element in final year projects for undergraduates studying robotics, electronic engineering and computer science.

This type of robotics competition is also popular in countries such as the USA, Japan, Australia, New Zealand, Singapore and Hong Kong. The many UK entrants can expect to be challenged by overseas competitors at the TIC event.

The adoption of the University of Central England (UCE)'s TIC

as venue for MICROMOUSE 2004 reflects its growing reputation as a leading UK university faculty of technology. The contest will be overseen by Professor Martin Smith who recently joined the Robotics Group at the tic.

Martin has been at the forefront of the popularisation of robotics which excites young people's interest in science and engineering as a career. A regular judge on the BBC's Robot Wars and technical presenter for Techno Games, Martin has supported the MICROMOUSE competition in the UK for more than ten years during which the event has become a challenge attracting international interest.

His co-supervisor is Dr Tony Wilcox, who has not only developed the micromouse as a major teaching aid, but also expects to see several TIC students competing in MICROMOUSE 2004.

Having developed the TIC micromouse platform and integrated this into the engineering curriculum, Dr Wilcox says: "It will be exciting to see our micromice, developed primarily for teaching at tic, compete against the best in the world at a major event hosted by tic. There will be both staff and student entries. It is attracting a lot of interest."

Professor Keith Osman, head of Automatic Identification and

The micro-robotics competition known as MICROMOUSE 2004 is to be hosted by the Technology Innovation Centre (TIC) at Birmingham's prestigious Millennium Point on Saturday, 19th of June 2004.

Intelligent Systems at tic, says: "I'm delighted we have attracted MICROMOUSE 2004 to the tic. Mobile robotics presents an attractive aspect of engineering and technology and excites many people. It also offers tremendous opportunities for involving young people in schools, colleges and universities in technology. Its importance is recognised by governments around the world and is integral to the educational curriculum in the USA.. We are seeking to raise the profile of this important discipline in the UK."

The reigning British Micromouse champion is local man Dave Woodfield of Bloxwich near Walsall. He will be pitched head-to-head with World Champion, Dave Otten from the USA at MICROMOUSE 2004 which will be held in the thinktank theatre at Millennium Point.

Full details of the day-long event and how to enter are being sent to potential entrants. Members of the public will have the opportunity of applying for free tickets to view the event.

### About tic, UCE and Millennium Point

Less than four years after its creation by the University of Central England (UCE) Birmingham's Technology Innovation Centre (the tic) has been rated as one of the country's top ten engineering faculties by the Guardian's 2003 University Guide.

The Guardian League Table for General Engineering shows the TIC at number nine, grouped with Strathclyde, Cambridge, Oxford, Westmin-

ster, Warwick, Loughborough, Durham, Brunel and Exeter. The TIC score in the table is the highest possible for value-added which measures the success of the TIC in helping students with lower entry qualifications to achieve good degrees. The table can be viewed at

<http://education.guardian.co.uk/higher/unitable/0,-4664351,00.html>

The Technology Innovation Centre (the tic) is a national centre of excellence for technology-based Lifelong Learning and Business Solutions, with Specialist Technologies, for individuals and for businesses. It provides cutting-edge resources and specialised knowledge structures to meet the needs of a rapidly developing technology-based society. The TIC is a significant initiative in the UK through which business development services and advanced technologies are made both accessible and affordable to companies of every size and type, whilst benefiting from and being rooted in a lifelong learning organisation, the University of Central England (UCE).

England's largest Millennium project outside London, Millennium Point cost £114 million, including £50 million of Millennium Commission lottery funding and £25.6 million from the European Regional Development Fund

**The Event Administrator,  
Rita Kerry,  
Tel. 0121-331-5400.  
E-mail: [rita.kerry@tic.ac.uk](mailto:rita.kerry@tic.ac.uk)  
Web: [www.tic-online.com](http://www.tic-online.com)**

(047011-1)

# Hands-on CPLDs

## Part I: Experimental rev counter

By A. Rosenkränzer

In the past Complex Programmable Logic Devices (CPLDs) have been something of a closed book to most semi-professional electronics enthusiasts but this hands-on series should go some way to help dispel that myth.

Times change. It wasn't long ago that programmable logic devices (PLDs) were thought to be the preserve of the specialist designer who with the help of expensive development environments and unwieldy

software emulators took months to cram large digital designs onto a single PLD. Nowadays the whole process has been simplified to such an extent that the only expensive bit

of kit you are likely to need is a PC. An interface adapter is also necessary to connect to the in-circuit programming socket of the CPLD circuit board but its cost is relatively low. When you add to this the fact that the price of the chips themselves have tumbled greatly and the development software is now freely available, these devices start to look attractive even to the hobbyist.

### Programmable Logic – An overview

Lift the lid on any piece of modern-day electronic equipment and you will be lucky to find any discrete components from say the '74' family of logic gates used in the design. Occasionally you may see a clock circuit or bus driver but these are essentially used for driving or buffering and do not have a logic function. High volume consumer products such as computer boards have all the logic functions implemented in ASICs (Application Specific Integrated Circuits). The per-unit cost of an ASIC is quite low but there is also the expensive (one off) mask cost to consider. The equipment manufacturer must be sure of the potential market before a commitment to use ASICs in a design is made.

In the equipment development

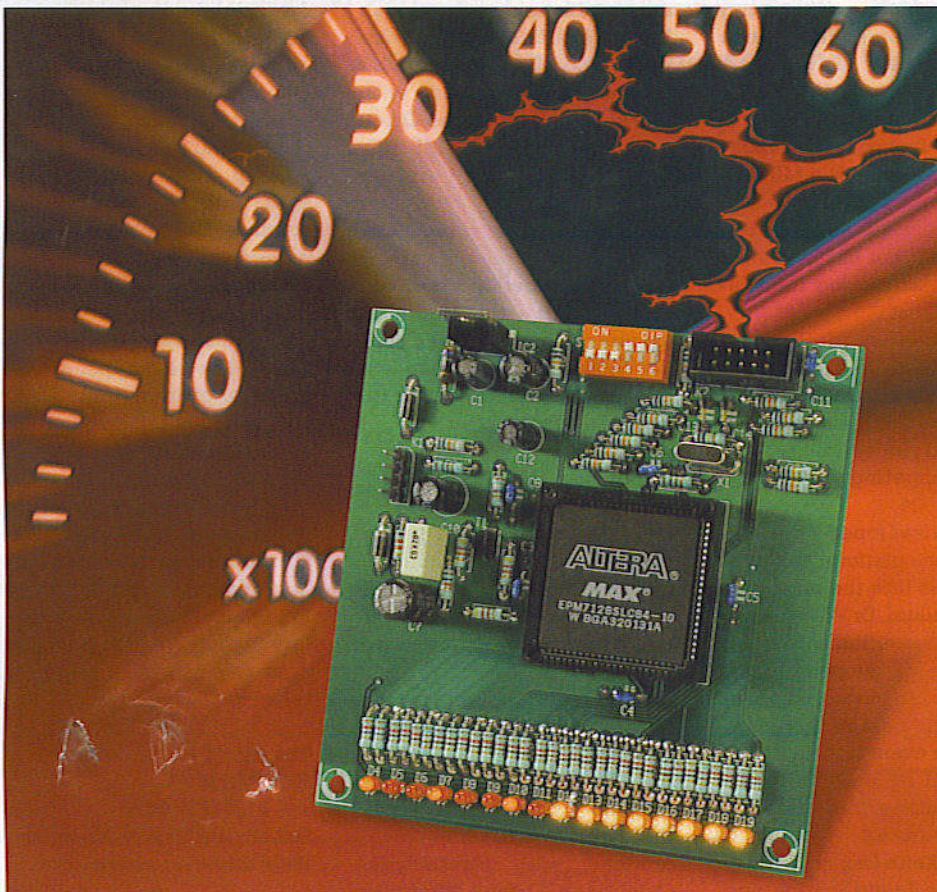

phase and also for low-volume production ASICs are not cost effective; here the favoured technology is the Programmable Logic Device or PLD. These devices started to appear back in the 80's and since then many more companies have got in on the act to offer bigger and better devices in all sorts of package outline and more recently with lower operating voltages.

The first examples had relatively few registers (flipflops), required a lot of external buffers/drivers and consumed quite a lot of power. On top of this there was also special equipment necessary to program the device. Most of these chips were one-time programmable so that if a mistake was made in programming or some function required modification then the programmed devices could not be reused. On cost alone (development and simulation software together with the programmer device) PLDs were never considered suitable for the hobbyist.

As we said at the beginning times change, PLDs now offer far more gates per package and have become reusable. The real breakthrough came with the 'in system programmable' devices. As the name suggests these chips are fitted permanently into the finished equipment and can be reprogrammed via a 10-pin JTAG interface connector fitted somewhere on-board. The interface allows several devices to be daisy-chained and programmed from just the one connector. The

devices do not require a socket so this has led to an increase in the device pin density right up to the BGA package outline. A few manufacturers still offer devices in the more user-friendly PLCC outline which is more suited to a typical hobbyist project.

The necessary development software from practically every chip manufacturer is now freely available for download from the Internet. A simple piece of hardware like the ByteBlaster from Altera is all that you need to connect a PC to the JTAG connector on the PCB. Regular readers will remember the ByteBlaster compatible 'Parallel JTAG Interface' design featured in the September 2002 edition of *Elektor Electronics*.

CPLDs (Complex PLDs) evolved from PLDs and the next step along the way is FPGAs (Field Programmable Gate Arrays). The main difference besides the increased complexity is that CPLDs (mostly using EEPROM technology) do not lose their programming data when the device is powered down.

In contrast FPGAs must be reprogrammed every time they are switched on. Reprogramming is performed automatically from a 'boot device' (either a serial EEPROM or flash memory) fitted to the PCB. The reason for this is that it is not yet possible to fabricate high-speed EEPROM technology at the necessary cell density required for an FPGA.

The clock speeds of FPGAs can be several hundred megahertz and some manufacturers are offering SERDES technology that pushes the data rate up to 3.7 Gbps (10 Gbps will no doubt be available by the time you read this) these devices include complete processor cores (ARM, NIOS). Dropping the supply voltage down from 5 V to around 1.5 V has also led to reduced power dissipation in the device.

Around 90% of all FPGA's sold are supplied by three manufacturers: Xilinx, Altera and Lattice. FPGAs have an enormous capacity of gates and can be used in thousands of applications. They also do not have the expensive one-off mask costs of an ASIC.

## Hands-on

This article and its follow-up does not concentrate too heavily on a theoretical textbook approach to the use of CPLDs in digital designs instead we use a practical hands-on method. Here we build a digital rev counter (tachometer) suitable for use in most cars or motorbikes.

The rev counter design is quite straightforward and should make a good introduction to the use of CPLD technology. This article takes you through the complete process of construction and programming and will give a good foundation and insights into the advantages of this type of technology.

The project is described using a top-down approach; first we will take a look at the block diagram and point out the features of the CPLD at the hardware level. Next we will consider the peripheral circuitry and finally (in the second part) the internal structure of the CPLD and the programming process is described.

Figure 1 shows the block diagram of the digital tachometer circuit. The central component is the CPLD 7128S from Altera, this chip does all the work and is surrounded by some peripheral circuitry.

An interface is required to convert the ignition pulse from the low-tension connection on the ignition coil to TTL levels and remove any noise spikes that may be present on this signal. The 'lighting' input signal controls the light intensity of the LED column (the 12 V to 5 V interface is not shown on this diagram but can be seen in detail in Figure 2). Under daylight viewing the intensity can be at maximum but at night it needs to be dimmed to avoid dazzling.

The chip is programmed over the JTAG interface using a ByteBlaster interface adapter from Altera (or a ByteBlaster compatible interface) which connects to a PC parallel port.

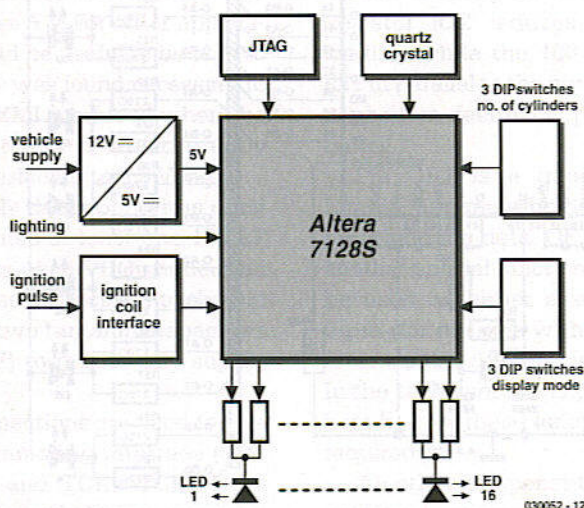

Figure 1. Block diagram of the digital rev counter.

A quartz crystal together with a few discrete components generates the chip clock. This clock is sufficiently accurate to ensure that the circuit will not require calibrating. The setting of three DIP switches allows the tachometer to be used on vehicles with different cylinder counts and ignition systems. Without reprogramming the circuit can be configured for one, two, three, four, six or eight cylinder engines using either single or double spark ignition. Three more DIP

switches are used to change the display mode. This allows the range of displayed revs to be changed to suit the performance of the vehicle engine:

1000 to 6000 rpm with a resolution of 3 LEDs per 1000 rpm.

750 to 4500 rpm with a resolution of 4 LEDs per 1000 rpm (Diesel mode).

2000 to 10000 rpm with a resolution of 2 LEDs per 1000 rpm (motorcycle engines).

4000 to 6000 rpm high resolution mode with 8 LEDs per 1000 rpm.

5000 to 7000 rpm (the so called 'Schumacher mode').

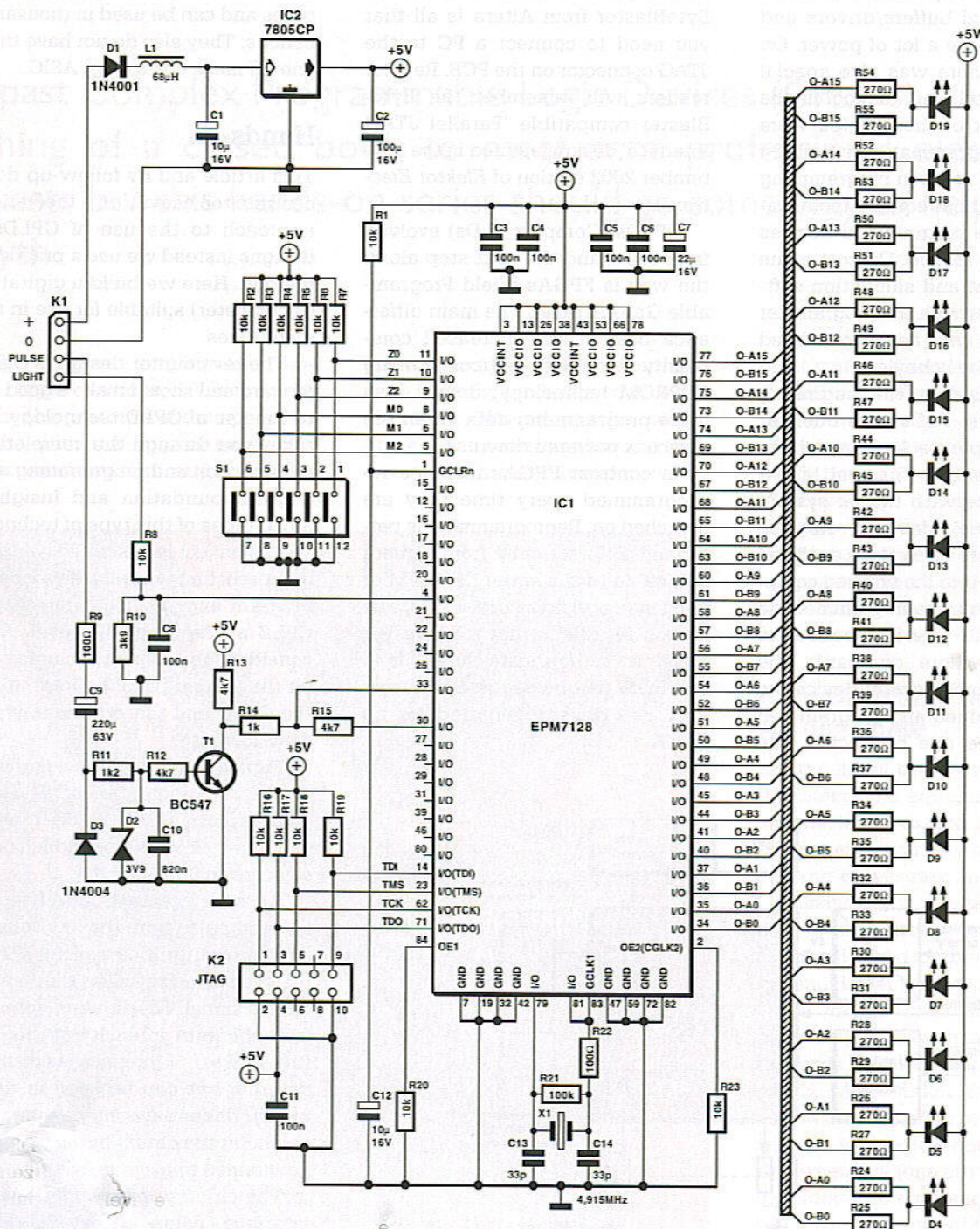

030052 - 11

Figure 2. The complete circuit.

Almost any type of display representation including non-linear can be programmed into the CPLD and selected by three DIP switches. To make programming easier there is an Excel spreadsheet available that calculates the frequency scaling necessary in the program given the oscillator frequency and the required display resolution.

The tachometer display consists of a single line of 16 LEDs. Each LED is driven by two outputs from the IC and through two series resistors. The reason for this is that the data sheet indicates that the maximum output current is limited to 12 mA; most standard LEDs require around twice this current if they are to be visible under daylight conditions. Low power LEDs could be used to solve the problem but here the use of two outputs to drive one LED gives us a simple method to indicate not just the rpm but also each 1000-rpm graduation that glow differently.

### The peripheral circuitry

Figure 2 shows the detail circuit diagram of the tachometer. IC1 is the CPLD type EPM7128S from Altera packaged in a 84-pin PLCC outline. The chip has a total of eight ground pins that must all be connected to GND.

There are also two types of VCC connection on the chip. Two of these connections (both called VCCINT) are connected to the core of the chip while the other six (VCCIO) supply power to the I/O buffers. This supply can be connected to either 3.3 V or as in our case 5 V. For other applications it would be useful to be able to use 3.3 V if it was found necessary to reduce the EMI produced when the buffers switch or it would greatly simplify interfacing to 3.3 V logic.

For supply decoupling it is good practice to use at least one 100 nF capacitor for each VCC connection sited as close as possible to the pin and one or two tantalum capacitors (10 to 22 µF) to reduce any supply rail noise.

Four connections are used for the JTAG programming interface (TDI, TMS, TDO and TCK). TCK is the clock input used during programming. TDI is not as you may have thought some kind of diesel engine

but in this case the data input signal. This signal together with the data output (TDO) allows several CPLDs to be daisy chained by connecting TDO to TDI of the next chip. The TDO of the last chip is then connected to the JTAG interface. TMS is used to configure the JTAG interface for reset, data, command, boundary scan and so on. All four pins are fitted with a 10 kΩ pull-up resistor.

The connector for the JTAG-Interface (K2) is a 10-way header plug. Along with the four signal wires are also ground and VCC to supply power to the programming adaptor (ByteBlaster). The four JTAG connections can also be used as general-purpose I/O pins but this is only advisable if there are no other I/O pins available.

R1 and C12 provide a reset pulse to the active low Global CLear input (GCLRn) during power-up. This reset clears all the chips internal registers.

GCLK1 is the first of the two global clock inputs. It is important to ensure that the first system clock for the CPLD is connected to this input and not to some general purpose I/O pin which is not internally wired to the cells and registers. Two I/O pins close to the GCLK1 input are used as a buffer to interface to the crystal. The output from the buffer is connected directly to GCLK1 input. Resistor R22 reduces the output loading while the 100 KΩ resistor R21 in parallel to the crystal provides a positive feedback path for the buffer.

Pin OE1 is a general Output Enable, and must be defined in the programming data. OE2 (GCLK2) is another special function pin and can be used as either a second clock input (for designs with two clocks) or as a second output enable input. In the tachometer design described here both of these functions are not required.

All other components and external signals are connected to general-purpose I/O pins. The criteria used to allocate these pins will be

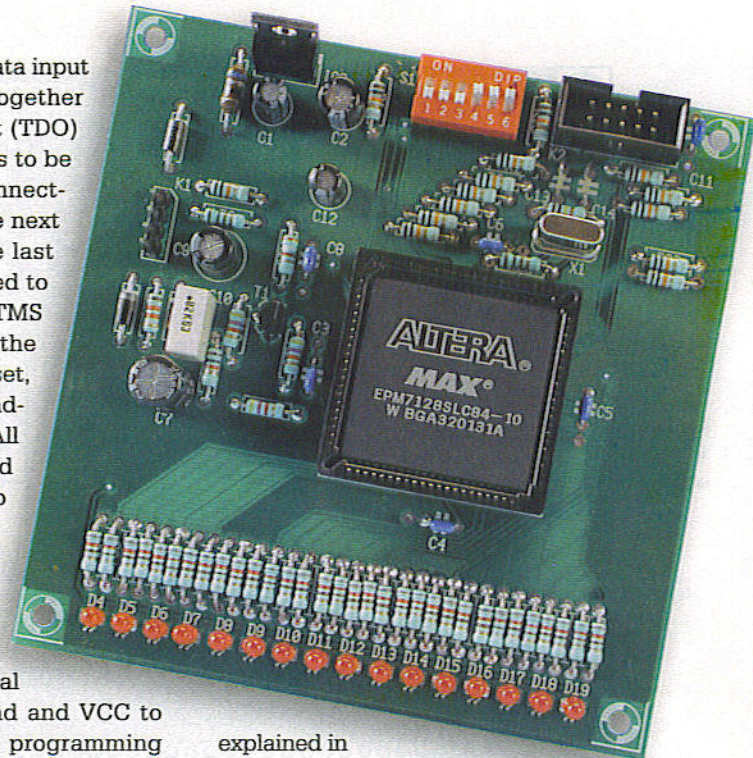

explained in the follow-up article in *Elektor Electronics*.

### The remainder

Power for the circuit is supplied by the 12 V vehicle battery via connector K1. Diode D1 prevents damage to the circuit if the supply polarity gets mixed up. L1 filters noise spikes on the supply to the 5 V regulator IC2 while C1 and C2 are also used to provide noise decoupling. The complete circuit takes about 0.5 A worst case so power dissipation in the voltage regulator is given by:

$$P_v = 0.5 \text{ A} \cdot (14.4 \text{ V} - 5 \text{ V}) \approx 5 \text{ W}$$

It is important to ensure that the heatsink for IC2 can dissipate this amount of energy.

The six way DIP switch S1 is used to select the vehicles engine cylinder count and the display mode. When a switch position is open circuited a 10 kΩ resistor pulls the line up to 5 V. R8 and R10 reduce the voltage on the 'light on' signal to TTL levels while C8 reduces any noise spikes on this input.

The signal from the ignition coil is conditioned by the circuitry around transistor T1, it produces a filtered TTL compatible output signal for IC1 from the 'raw' ignition signal. C9 AC couples the signal. The negative transition of the pulse is clamped to -0.7 V by diode D3 while R9 protects D3 from excess power dissipation. R11 and zener diode D2 limit the positive level of the pulse to 4 V. C10 filters out high frequency noise while R12, T1 and R13 form a transistor switch which produces a clean TTL compatible output pulse to the IC from the noisy ignition signal.

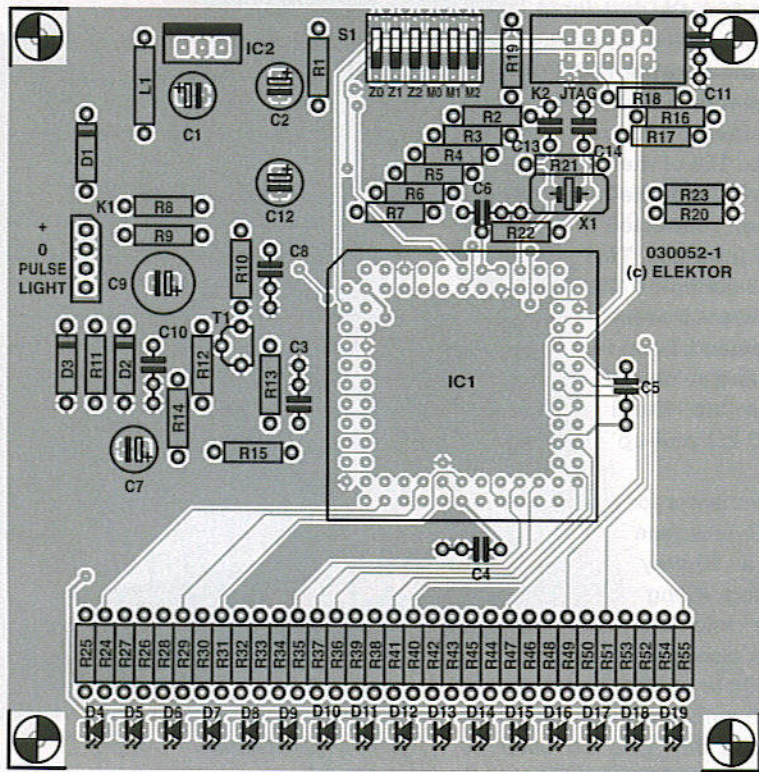

Figure 3. Component mounting plan for the double-sided PCB.

## COMPONENTS LIST

### Resistors:

R1-R8, R16-R20, R23 = 10k $\Omega$   
 R9, R22 = 100 $\Omega$   
 R10 = 3k $\Omega$   
 R11 = 1k $\Omega$   
 R12, R13, R15 = 4k $\Omega$   
 R14 = 1k $\Omega$   
 R21 = 100k $\Omega$   
 R24...R25 = 270 $\Omega$

### Capacitors:

C1, C12 = 10 $\mu$ F 16V radial  
 C2 = 100 $\mu$ F 16V radial  
 C3-C6, C8, C11 = 100nF  
 C7 = 22 $\mu$ F 16V radial  
 C9 = 220 $\mu$ F 16V radial  
 C10 = 820nF  
 C13, C14 = 33pF

### Semiconductors:

D1, D2, D3 = 1N4001  
 D2 = zener diode 3V9, 500 mW  
 D4...D19 = LED, green, 3 mm  
 IC1 = EPM7128SLC84-15  
 IC2 = 7805CP  
 T1 = BC547A

### Miscellaneous:

K1 = 4-way SIL pinheader  
 K2 = 10-way pinheader  
 L1 = 68 $\mu$ H choke  
 S1 = 6-way DIP switch  
 X1 = 4.9152MHz quartz crystal  
 PCB, available from The PCBShop  
 Disk, order code 030052-11 or  
 Free Download

## Web Addresses

[www.xilinx.com](http://www.xilinx.com)  
[www.coolpld.com](http://www.coolpld.com)



[www.altera.com](http://www.altera.com)



[www.latticesemi.com](http://www.latticesemi.com)



Resistors R14 and R15 control the hysteresis of a Schmitt trigger input. This is quite important because any noise on the ignition input signal would cause the tachometer to give a false reading. R15 provides the feedback from the output side of the input buffer. When the buffer changes state a small proportion of its output is fed back out from pin

30 on IC1 to reinforce the input signal via R15. This has the effect of shifting the voltage threshold at which the buffer can switch back (hysteresis) and so masking the effects of noise on the input.

## The PCB and future developments

A double-sided PCB has been produced specifically for this tachometer project. The PCB and component placement diagram is shown in Figure 3. Component mounting should be fairly straightforward but take care not to allow any solder debris to enter underneath the PLCC socket where it could short between PCB tracks. Correct orientation of the IC is important so ensure that the clipped corner of the package outline corresponds to the corner of the socket and silk-screen printed IC outline on the PCB. Ensure correct polarity of the LEDs, capacitors and diodes when they are fitted to the board.

When any circuit uses a line of discrete LEDs the finished project always looks a bit amateurish if the LEDs are not uniformly in-line. A

good tip here is to firstly solder just a single leg of each LED in place. The board can now be flipped over and all the LEDs carefully bent or resoldered into exactly the right position before the second leg of the LEDs are soldered.

The layout is not too cramped so there is no reason why this PCB could not also be used as a development platform to prototype other CPLD designs. Those of you however who are looking for the flexibility of a true evaluation board should not be disappointed by our EVA-board that we shall be featuring in a forthcoming article in *Elektor Electronics*.

In the second part of this article we will take a closer look at the CPLD internals and device programming.

## Free Downloads

Excel spreadsheet.  
 File number: 030052-11.zip  
 PCB layout in PDF format.  
 File number: 030052-1.zip

[www.elektor-electronics.co.uk/dl/dl.htm](http://www.elektor-electronics.co.uk/dl/dl.htm),  
 select month of publication.



## Compact GPRS/GSM Modem



Alpha Micro Components ([www.alphamicro.net](http://www.alphamicro.net)) has launched a brand new 'AMC1802GSXLA' dual band GPRS1/GSM2 embedded radio modem module. Developed using RIM's superior radio modem, the module is ideally suited for transmitting data to and from wireless mobile elec-

tronic devices such as point-of-sale terminals and metering equipment.

Measuring just 90mm x 56mm, this highly compact modem module supports both the existing GSM radio standard and the new GPRS 'always on' radio

connection. Unlike a GSM connection, which is billed on a cost-per-second basis, GPRS is charged on the basis of cost-per-byte transferred. Once a GPRS connection has been established with the service provider's host, the module may remain online at no cost to the user, ready to receive or

transmit data. By running TCP/IP and PPP on board, the AMC1802GSXLA radio module may be interrogated simply as an Internet address from any web browser.

Features include voice support and front end sensitivity 108 dBm typical. PPP, IP, TCP, PAP, and CHAP protocols are supported over the GPRS network in addition to modem emulation up to V.32 over GSM.

The module runs from a single 5Volt supply and drives a 5 volt serial interface with baud rate selectable up to 115,200 bps. The radio SIM module may be sited either on the user's motherboard or on the AMC1802GSXLA module itself.

Control of the modem is via a standard AT command-driven

serial interface with extended register settings for the GPRS option. In this way, the AMC1802GSXLA may be seen as a simple dial-up analogue modem to any existing user application.

Variants of this module incorporating GPS (Global Positioning System) capabilities and 12 volt power source are currently under development for asset management and vehicle tracking systems.

Alpha Micro, Springfield House,  
Cranes Road, Sherborne St. John,  
Basingstoke,  
Hampshire RG24 9LJ,  
United Kingdom,  
Tel: + 44 (0)1256 851770,  
fax: + 44 (0)1256 851 771.  
Web: [www.alphamicro.net](http://www.alphamicro.net)

(047012-1)

## New Catalogue of Antennas

Alpha Micro's Special Products Division is pleased to present a new and extensive range of antennas for home, mobile, fixed, hand portable and GPRS use ([www.alphamicro.net](http://www.alphamicro.net)).

Featuring a wide range of top quality antennas, including single and dual band, 2.4 GHz, DECT and Bluetooth, Alpha Micro provides antennas to suit any requirements from a large catalogue of worldwide manufacturers and suppliers. Responding to the increasing demand for mobile and global positioning systems, Alpha Micro is offering an unrivalled selection of GPS and GSM antennas. Included in the range is an ingenious 'covert tax disc antenna' that can be discreetly installed behind a vehicle's displayed tax disc

and is GSM and GPS enabled, allowing the vehicle to take advantage of both communication and location services.

Other offerings include the magnetic mount GPS antenna — a discreet externally mounted device with 3 V or 5 V DC voltage, SMA plug and 5 m RG174. Stylish 'shark-fin' GPS and GSM antennas are also available.

Lightweight base stations are offered such as the KITB — an ideal local base station with end fed half wave, a base-load whip and 3dB gain. The antenna has a VHF and UHF frequency range and comes with a five-metre cable.

Hand portable antennas featured include the M4UHF85 — a flexible, overmoulded portable antenna with built-in

strain relief, 8.5-mm long M4 thread, helical wound and UHF tuned frequency. Mobile antennas ideal for installation on vehicles include the CAB-MAG 6mm, a mounted, high strength antenna with a rubber overmould and four rare earth magnets. For high vehicles, the low profile antenna LOWPROUHF is on offer, providing top quality reception without the inconvenience of adding extra height.

Alpha Micro is also pleased to offer an acclaimed selection of wireless antennas, including unobtrusive panel antennas for Bluetooth and IEEE802.11, internal and external rubber antennas, OMNI and Yagi antennas.

Alpha Micro, Springfield House,  
Cranes Road, Sherborne St. John,

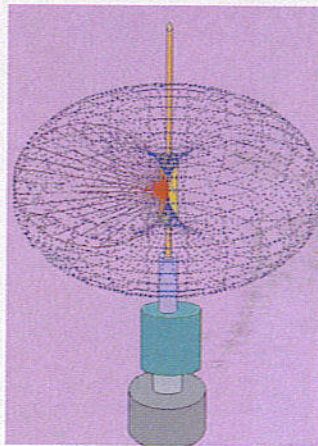

Basingstoke,  
Hampshire RG24 9LJ,  
United Kingdom,  
Tel: + 44 (0)1256 851770,  
fax: + 44 (0)1256 851 771.  
Web: [www.alphamicro.net](http://www.alphamicro.net)

(047012-3)

The internet site for all professionals and hobbyists  
actively engaged in electronics and computer technology

[www.elektor-electronics.co.uk](http://www.elektor-electronics.co.uk)

# Digital Alarm Clock

Based on a PIC micro

Design by M. Conde de Almeida

maconde@terra.com.br

Although digital alarm clocks have been around for years, most of today's off the shelf products suffer from serious design limitations. For example, many don't keep track of weekdays and can only store one alarm time. High time for a home-brew design that does a better job.

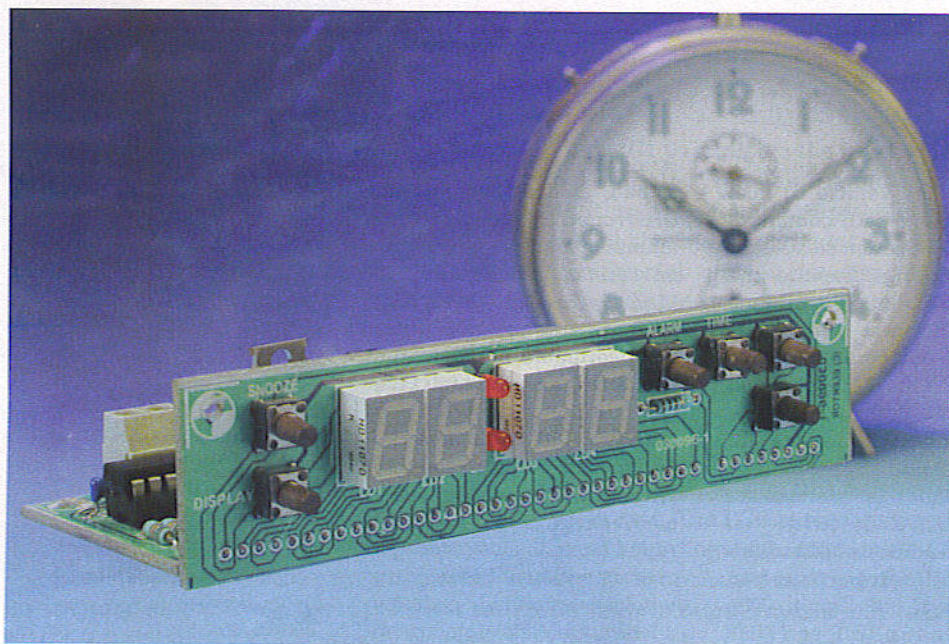

Off the shelf alarm clocks present a serious limitation if, for instance, you and your partner have different wake-up times or if you have to give or take medication at regular intervals. This limitation gets more serious if you want alarms to go off only on specific days of the week or only during work days. The time setting process on most clocks is also subject to improvement. In the majority of cases you adjust time by incrementing minutes and hours. If your clock is at, say, 06:15h and the correct time is 20:58h you need to keep a key pressed for quite some time and release it well

before the desired hour/minute, switching to 'slow' setting. If not, you're past the desired time and have to start all over again.

This article proposes a solution for these design weaknesses by discussing a low-cost circuit based on the popular PIC 16F84A microcontroller from Microchip.

Our digital alarm clock keeps track of weekdays and has eight alarms that can be individually set to go off every day, only on working

days or, if you want, on a specific day of the week.

The time setting process allows the adjustment of each digit of the clock separately by means of Up and Down (+ and -) keys. It also incorporates some other interesting features.

Like all good digital alarm clocks our project has a battery that keeps the clock ticking in the event of an AC power failure. In battery-powered mode the display is turned off to reduce energy consumption. However, if you want to check the time you may still enable the display by pressing a 'display on' button. In battery mode the alarms will continue to operate normally. When an alarm goes off the display will be turned on to show the current time.

The eight different alarm times are kept in the PIC's EEPROM. So, you won't have to adjust any of the alarms again even if the battery fails. A 'snooze' key will temporarily turn an alarm off. The alarm will be triggered again after a minute until it is definitely turned off. A master Alarm On/Off key will enable/disable all the alarms, independent of their individually set states. A bright LED display makes it easy to check the time from a distance or in the dark.

The 4-MHz crystal oscillator guarantees a pretty accurate timebase for the clock (error = 0.000427%).

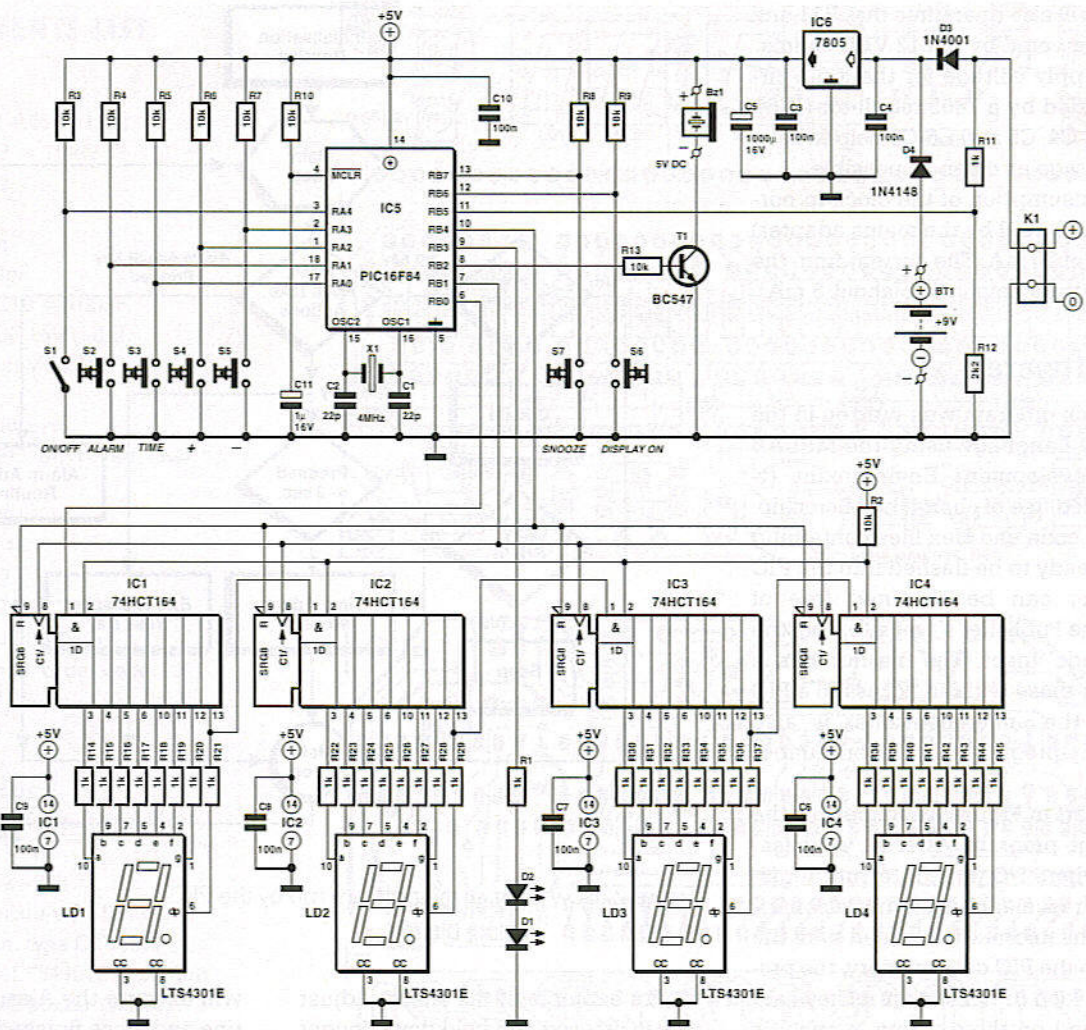

Figure 1. Circuit diagram of the PIC-based Digital Alarm Clock.

### The hardware

Figure 1 shows the complete circuit diagram of the clock. All intelligence (and a lot of logic) is vested in the PIC16F84 MCU in position IC5. Using RA0-RA4 and RB5-RB7 as input port lines and RB0-RB4 as output port lines, a fair amount of executable code run from the on-chip memory is able to take total control of the circuit, requiring just a 5-V supply voltage and a clock signal generated with the aid of an external 4-MHz quartz crystal, X1.

Components R10 and C11 guarantee that the microcontroller is reset at power-on.

Switches S1-S5 are connected to the microcontroller's PORTA pins (all configured as inputs). Resistors R3-R7 guarantee a High logic level at the PORTA pins when the switches are open. When closed, these keys will force a LOW state on the PORTA

pin they are connected to, triggering the execution of specific clock control routines.

PORTB.6 and PORTB.7 are also configured as inputs. R8 and R9 guarantee a High logic level at these inputs when the associated switch S6 or S7 is open. S7, when closed, will activate the 'Snooze' function. Similarly, S6 will temporarily activate the display. This function is only available when the clock is operating in the battery mode.

Resistors R11 and R12 form a voltage divider fed by the main 12 VDC source. They guarantee a High logic level at PORTB.5 when the main supply voltage is available. In this situation the display will be permanently on. If for some reason the main power is not available (AC power failure) there will be a Low logic level at PORTB.5 and the entire display will be turned off by the software.

Looking at the output devices controlled by the PIC, the alarm buzzer Bz1 is driven via PORTB.2 while PORTB.3 controls LED1 and LED2, the Hour/Minute separator in the readout.

Four common-cathode 7-segment displays, LD1-LD4 constitute the clock readout. These displays are driven by four 74HCT164 shift registers (IC1-IC4) connected in series. R2 only serves to guarantee a High level to the enable pins of the shift registers. PORTB.1 drives the CLOCK pin (8) of the shift registers while PORTB.0 drives the DATA line of the first shift register in the chain (IC1, pin 1). The microcontroller program will clock 32-bit strings into the shift registers whenever a display update is necessary. PORTB.4 controls the RESET pin of the shift registers. This port line will be held Low when the display is to be turned off.

The regular 12 VDC power may be supplied by a standard AC or DC adapter. Diodes D3 and D4 will guarantee exclusive operation of either the 9 V battery or the 12 VDC power

source. They will also guarantee that R11 and R12 are only powered by the 12 VDC source.

The 5 V supply voltage for the logic circuitry is provided by a 7805 regulator (IC6). Capacitors C3, C4, C5 and C6-C9 help to keep the supply voltage as clean as possible.

Current consumption of the clock in normal use (i.e., powered by the mains adapter) is of the order of 75 mA. The current from the 9-V backup battery amounts to about 5 mA.

## Control software

The entire clock program was written in the PIC Assembly Language using the MPLAB Integrated Development Environment (v. 5.70.40) supplied free of charge by Microchip.

The source code and Hex files containing the program ready to be flashed into the PIC microcontroller can be obtained free of charge from the Publisher's website, see 'the Free Downloads' inset. The file number is 030096-11. For those without access to a PIC programmer, the microcontroller is also available ready-programmed under number 030096-41.

The flowchart in Figure 2 summarizes the operation of the program. After an initialisation routine where I/O pins, Interrupt register, Timer\_0/Prescaler operation are configured and alarms information is read from the EEPROMs into the PIC data memory, the program enters a loop in which control keys are read and, based on their status, a specific branch is taken.

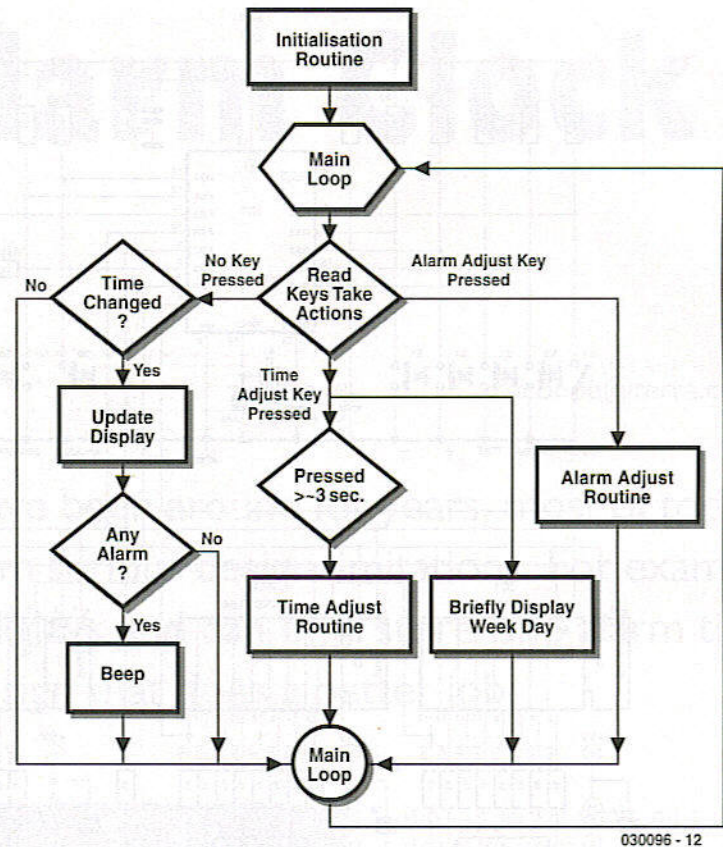
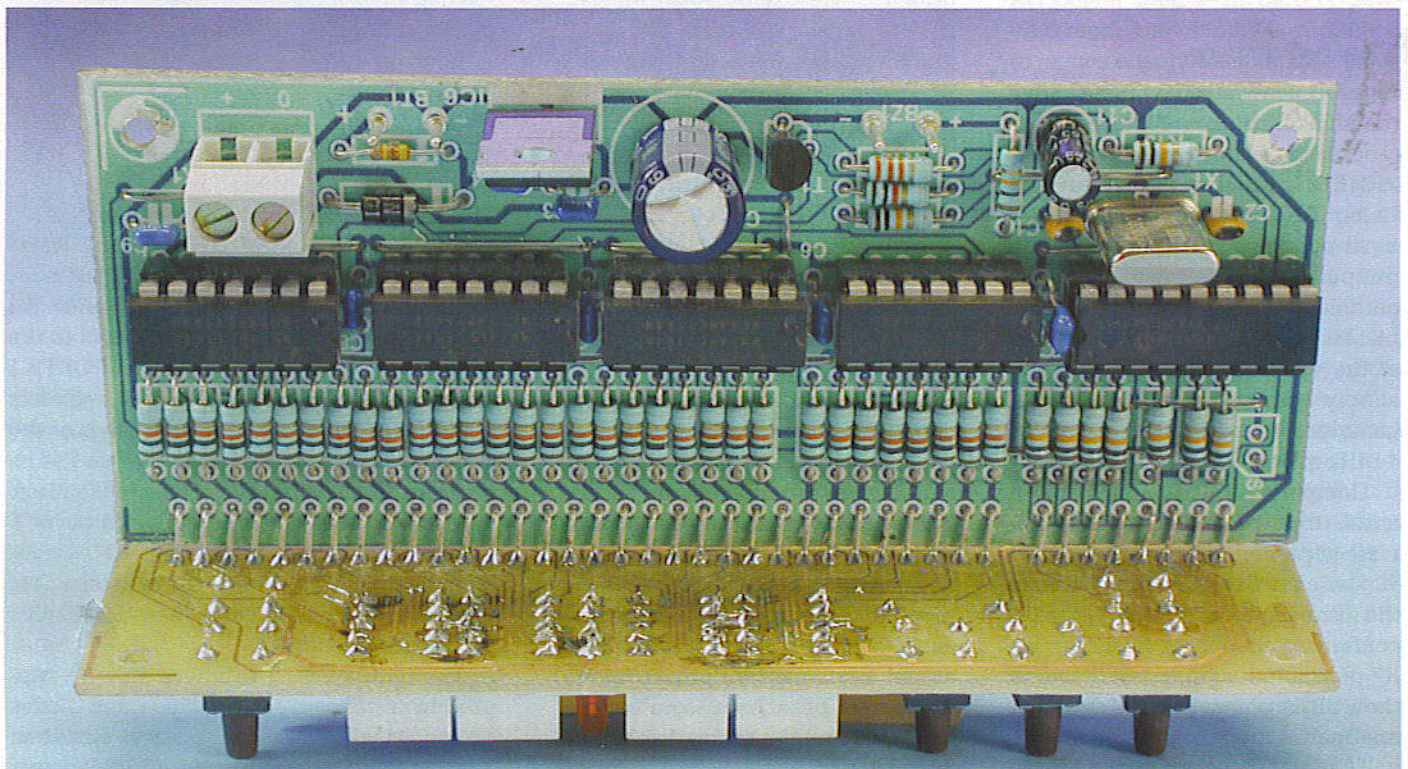

Figure 2. Flow chart of the program run by the PIC.

For example, if the Alarm Adjust key is pressed and held down longer than about 3 seconds, the program

will execute the Alarm Adjust Routine and, once finished, return to the main loop.



**COMPONENTS LIST**

**Resistors:**

R1, R11, R14-R45 = 1kΩ  
 R2...R10, R13 = 10kΩ  
 R12 = 2kΩ

**Capacitors:**

C1, C2 = 22pF  
 C3, C4, C6-C10 = 100nF  
 C5 = 1000μF 16V radial  
 C11 = 1μF 16V radial

**Semiconductors:**

D1, D2 = LED, 3mm, red, low-current  
 D3 = 1N4001  
 D4 = 1N4148  
 T1 = BC547  
 IC1-IC4 = 74HCT164  
 IC5 = PIC16F84-04/p, programmed, order code 030096-41  
 IC6 = 7805

**Miscellaneous:**

K1 = 2-way PCB terminal block, lead pitch 5mm  
 S1 = on/off switch  
 S2-S7 = miniature PCB mount pushbutton, type DTS65N  
 LDI-LD4 = LTS4301E (Lite-On)  
 BZ1 = 5VDC buzzer (active)  
 X1 = 4MHz quartz crystal  
 BT1 = 9V battery with and clip-on lead  
 PCB, available from **The PCBShop**  
 Disk, PIC source and hex (object) code files, order code 030096-11 or Free Download

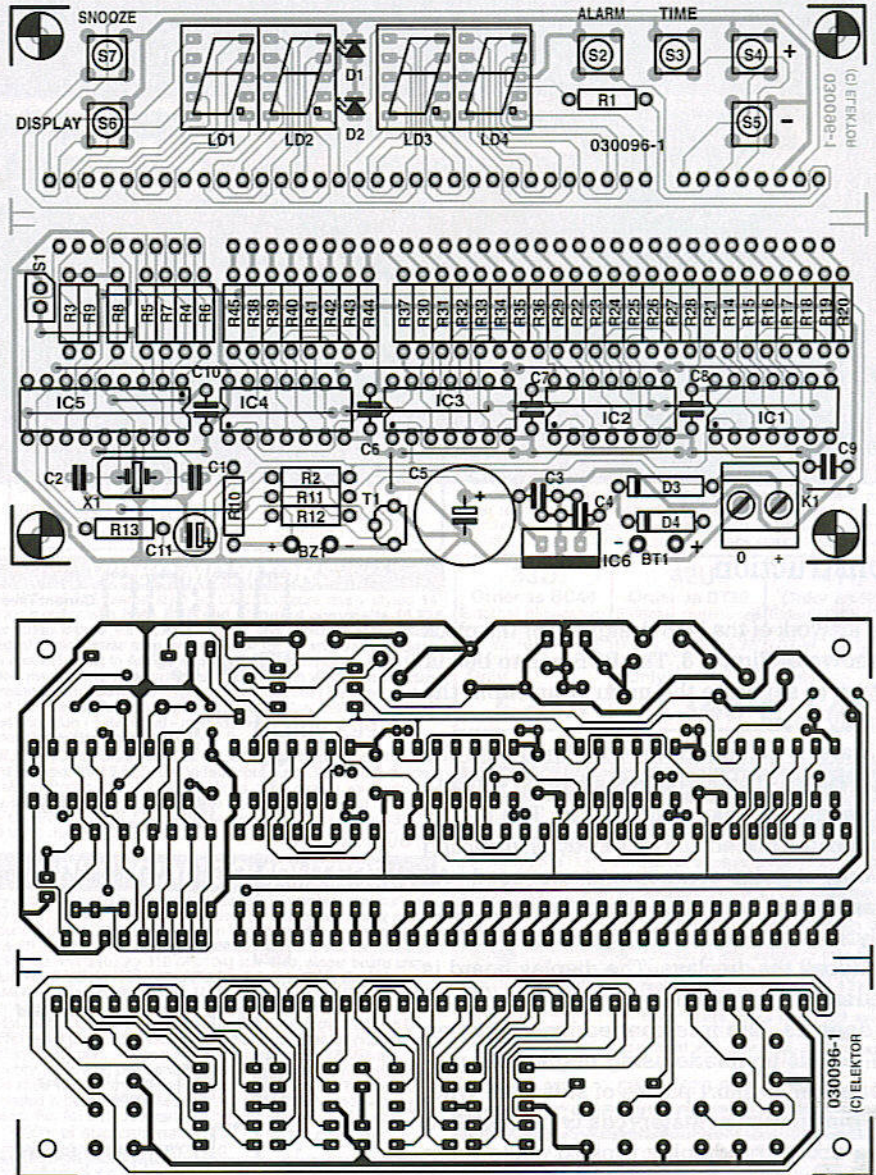

Figure 3. Copper track layout and component mounting plan of the PCB designed for the clock (board available from The PCBShop).

If the Time Adjust key is held depressed for less than about 3 seconds, the display will show the current weekday. If the key remains pressed longer than about 3 seconds, the program will execute the Time Adjust routine and, once time and weekday are adjusted, return to the main loop.

When no key is pressed the program keeps updating the display, checking the current time against the alarm entries in memory and triggering the beeper if a matching times are found.

Although it has not indicated by flowchart, the display updating process is affected by the status of

the PORTB.5 line (12 VDC supply current monitor) while the alarm verification and triggering processes are subject to the status of Alarm On/Off and Snooze keys.

One important piece of the software is the time counting process. It is based on the microcontroller TIMER\_0 which has the ability to interrupt the main program and deviate its execution to an interrupt handling routine whenever its count overflows (FFh → 00h).

The microcontroller is configured so that the TIMER\_0 overflow will take place every 2.048 ms. This is accomplished by setting the prescaler to divide the TIMER\_0 clock by eight.

Whenever called, the interrupt handling routine, will increment a 16-bit counter. This counter has a maximum count of 29,297 (7271h). This means that every minute (29,297 × 2.048 ms = 60,000.256 ms or very close to one minute) it will overflow.

The overflow of the 16-bit counter increments the minute-counter (modulo-10) which, after overflowing, increments the tens-of-minutes counter (modulo-6) which increments the hour-counter and sure it will finally increment the tens-of-hours counter.

As shown above, the clock's minute is slightly longer than it should be. This error, amounting to 0.000427%, will cause a time difference of less than two minutes per year which is pretty low compared to what is achieved by most the off-the-shelf clocks.

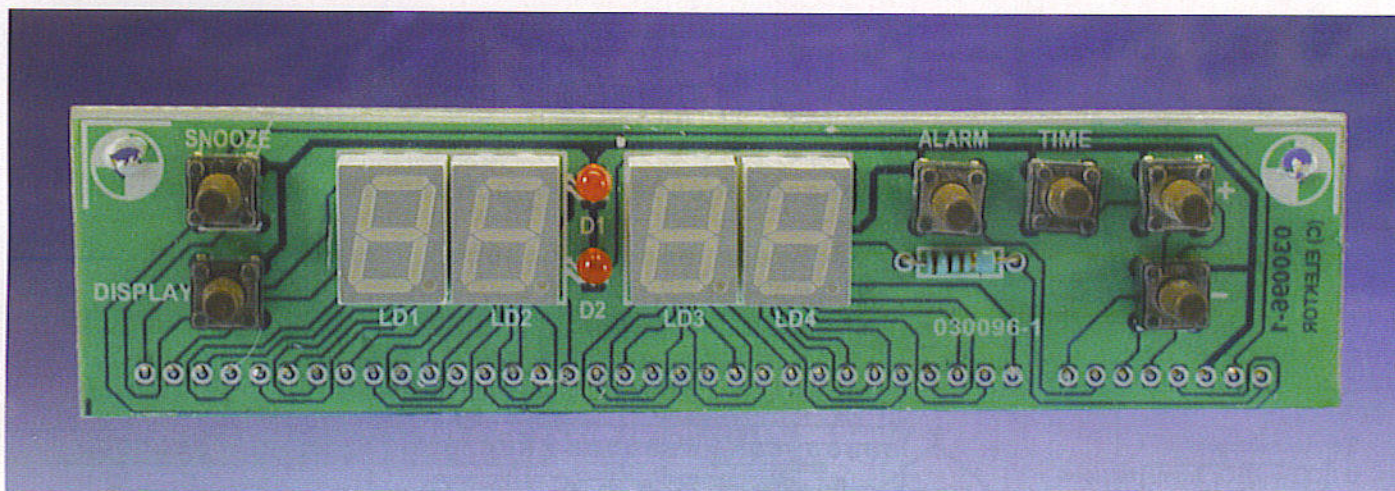

### Construction

The artwork of the PCB designed for the clock is shown in **Figure 3**. The PCB has to be cut in two to separate the main board from the display board.

Start by soldering the wire links onto the main board. Then follow the five IC sockets and all low-profile components. The rest of the construction should be mostly plain sailing as only regular components are used. As always, take care with the polarity of electrolytic components like capacitors, diodes and (yes!) the displays. The display board is secured to the main board at an angle of 90 degrees. The interconnections between the boards are made using angled SIL pin-headers or 40 short pieces of stiff, bare wire. The pushbutton actuator rods will protrude a little above the display tops to make them accessible from the outside once the PCB assembly has been mounted behind the front panel. A red bezel may be used as a finishing touch to enhance the appearance of the clock.

Using a multimeter, make sure that there's no short circuits between the +5 V supply rail and ground.

When inserting the integrated circuits always check the correct 'pin 1' position. Finally, avoid ESD damage to your circuit by keeping yourself grounded by means of wrist straps.

### Clock operation

The Time adjustment is shown pictorially in **Figure 4**. Other drawings are available but not printed here for lack of space. They include:

- clock display;
- keys and their functions;
- alarm on/off key operation;
- buzzer control procedure;

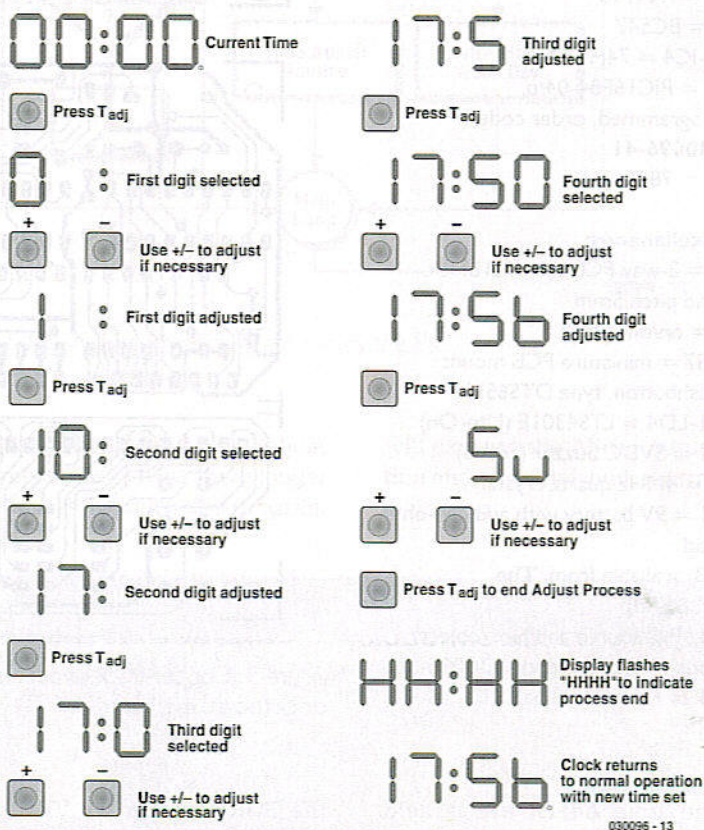

Figure 4. Time adjustment procedure.

- operation in battery mode (mains power failure);
- alarm adjustment,

The pictures are supplied in the form of a (zipped) pdf document — see this month's Free Downloads, number **030096-12**.

(030096-1)

### Free Downloads

PIC source and hex (object) code. File number: **030096-11.zip**  
 Clock operation pictograms. File number: **030096-12**  
 PCB layout in PDF format. File number: **030096-1.zip**  
[www.elektor-electronics.co.uk/dl/dl.htm](http://www.elektor-electronics.co.uk/dl/dl.htm), select month of publication.

Visit our website  
www.distel.co.uk

# THE ORIGINAL SURPLUS WONDERLAND!

THIS MONTH'S SELECTION FROM OUR VAST EVER CHANGING STOCKS

Surplus always  
wanted for cash!

## GIANT 10" 7 SEGMENT DISPLAYS

A bulk purchase enables us to bring to you these GIANT 7 segment digital displays at a now affordable price! The 10" character size gives exceptional readability at long distances and enables a host of applications including score boards, digital clocks, counters, event timers etc. As the units are a simple electromechanical device and operate from 12V DC, simple switching via switches, relays, PIC or PC may be used to control single or multiple digits. Units feature integral Zero Power memory which greatly simplifies design. For an excellent DIY practical article, see the May issue of 'Everyday & Practical Electronics' magazine. Ideal School / College construction project. Supplied in good RFE condition, complete with data sheet.



10" 7 segment display

Less than 30% of makers price! Only £29.95(B) or 4 / £99.00(D)  
Order RW44 Order PH26

## THE AMAZING TELEBOX



TV SOUND & VIDEO TUNER  
CABLE COMPATIBLE\*

Converts your colour monitor into a QUALITY COLOUR TV!!

The TELEBOX is an attractive fully cased mains powered unit, containing all electronics ready to plug into a host of video monitors or AV equipment which are fitted with a composite video or SCART input. The composite video output will also plug directly into most video recorders, allowing reception of TV channels not normally receivable on most television receivers (TELEBOX MB). Push button controls on the front panel allow reception of 8 fully tunable off air UHF colour television channels. TELEBOX MB covers virtually all television frequencies VHF and UHF including the HYPERBAND as used by most cable TV operators. Ideal for desktop computer video systems & PIP (picture in picture) setups. For complete compatibility - even for monitors without sound - an integral 4 watt audio amplifier and low level Hi Fi audio output are provided as standard. Brand new - fully guaranteed.

TELEBOX ST for composite video input type monitors £36.95  
TELEBOX STL as ST but fitted with integral speaker £39.50  
TELEBOX MB Multiband VHF/UHF/Cable/Hyperband tuner £69.95  
For overseas PAL versions state 5.5 or 6 mhz sound specification.  
\*For cable / hyperband signal reception Telebox MB should be connected to a cable type service. (Shipping on all Telebox's, code B)

**NEW** State of the art PAL (UK spec) UHF TV tuner module with composite 1V pp video & NICAM Hi fi stereo sound outputs. Micro electronics all on one small PCB only 73 x 160 x 52 mm enable full tuning control via a simple 3 wire link to an IBM pc type computer. Supplied complete with simple working program and documentation. Requires +12V & +5V DC to operate. BRAND NEW - Order as MY00. Only £39.95 code (B)  
See www.distel.co.uk/data\_my00.htm for picture + full details

## HARD DISK DRIVES 2 1/2" - 14"

2 1/2" TOSHIBA MK1002MAV 1.1Gb laptop (12.5 mm H) New £59.95  
2 1/2" TOSHIBA MK4313MAT 4.3Gb laptop (8.2 mm H) New £105.00  
2 1/2" TOSHIBA MK6409MAY 6.1Gb laptop (12.7 mm H) New £98.00  
2 1/2" TOSHIBA MK1814GAV 18 Gb laptop (12 mm H) New £149.95  
2 1/2" to 3 1/2" conversion kit for PC's, complete with connectors £15.95  
3 1/2" COMPAQ 313705-B21 (IBM) 9 gb ULT/SCSI3 New £199.00  
3 1/2" FUJI FK-309-26 20mb MFM I/F RFE £59.95  
3 1/2" CONNER CP3024 20 mb IDE I/F (or equiv.) RFE £59.95  
3 1/2" CONNER CP3044 40 mb IDE I/F (or equiv.) RFE £69.00  
3 1/2" QUANTUM 40S Prodrive 42Mb SCSI I/F, New RFE £49.95  
5 1/4" MINISCRIBE 3425 20mb MFM I/F (or equiv.) RFE £49.95  
5 1/4" SEAGATE ST-238R 30 mb RLL I/F Refurb £69.95  
5 1/4" CDC 94205-51 40mb HM MFM I/F RFE tested £69.95  
5 1/4" HP 97548 850 Mb SCSI RFE tested £99.00  
5 1/4" HP C3010 2 Gbyte SCSI differential RFE tested £195.00  
8" NEC D2248 85 Mb SMD Interface. New £99.00  
8" FUJITSU M2322K 150Mb SMD I/F RFE tested £195.00  
8" FUJITSU M2392K 2 Gb SMD I/F RFE tested £345.00  
Many other floppy & H drives, IDE, SCSI, ESDI etc from stock, see website for full stock list. Shipping on all drives is code (C)

## TEST EQUIPMENT & SPECIAL INTEREST ITEMS

MITSUBUSHI FA3451ETKL 14" Ind. spec SVGA monitors £245  
FARNELL 0-60V DC @ 50 Amps, bench Power Supplies £995  
FARNELL AP3080 0-30V DC @ 80 Amps, bench Supply £1850  
KINGSHILL CZ4031/1 0-50V @ DC 200 Amps - NEW £3950  
1kW to 400 kW - 400 Hz 3 phase power source - ex stock £90A  
IBM 8230 Type 1, Token ring base unit driver £760  
Wayne Kerr RA200 Audio frequency response analyser £2500  
INFODEC 1U, 24 port, RJ45 network patchpanels. #TH93 £49  
3COM 16670 12 Port Ethernet hub - RJ45 connectors #LD97 £69  
3COM 16671 24 Port Ethernet hub - RJ45 connectors £89  
3COM 16700 8 Port Ethernet hub - RJ45 connectors New £39  
IBM 53F5501 Token Ring ICS 20 port lobe modules £39  
IBM MAU Token ring distribution panel 8228-23-3050N £45  
IBM 501 Low distortion Oscillator 9Hz to 330KHz, IEEE I/O £550  
ALLGON 8360, 11605-1880 MHz hybrid power combiners £250  
Trend DSA 274 Data Analyser with G703(2M) 64 I/O £4500  
Marconi 6310 Programmable 2 to 22 GHz sweep generator £1550  
Marconi 2022C 10KHz-1GHz RF signal generator £3750  
HP1650B Logic Analyser £1800  
HP621A Pattern generator & HP3782A Error Detector £1800  
HP6264 Rack mount variable 0-20V @ 20A metered PSU £475  
HP54121A DC to 22 GHz four channel test set £475  
HP18130A opt 020 300 MHz pulse generator, GPIB etc £7900  
HP A1, A0 8 pen HPGL high speed drum plotters - from HP DRAFTMASTER 1.8 pen high speed plotter. £750  
EG&G BROOKFIELD 95035C Precision laser in amp £1800  
Keithley 590 CV capacitor / voltage analyser £3750  
Racal ICR40 dual 40 channel voice recorder system £4500  
Fiskers 45KVA 3 ph On Line UPS - New batteries £1499  
Emerson AP130 2.5KVA Industrial spec UPS £2200  
Mann Tally MK645 High speed line printer £945  
Intel SBC 486/133SE Multibus 466 system. 6Mb Ram

## IC's - TRANSISTORS - DIODES

OBSOLETE - SHORT SUPPLY - BULK  
10,000,000 items EX STOCK

For MAJOR SAVINGS  
CALL or see web site www.distel.co.uk

## COMPUTER MONITOR SPECIALS

Legacy products  
High spec genuine multisync.  
CGA, EGA, VGA, SVGA

Mitsubishi FA3415ETKL 14" SVGA Multisync colour monitor with fine 0.28 dot pitch tube and resolution of 1024 x 768. A variety of inputs allows connection to a host of computers including IBM PC's in CGA, EGA, VGA & SVGA modes, BBC, COMMODORE (including Amiga 1200), ARCHIMEDES and APPLE. Many features: Etched facelplate, test switching and LOW RADIATION MPR specification. Fully guaranteed, in EXCELLENT like used condition. Tilt & Swivel Base. £475

VGA cable for IBM PC Included. Only £129 (E) Order as CG73

External cables for other types of computers available - CALL

## Generic LOW COST SVGA Monitors

We choose the make, which includes Compaq, Mitsubishi, IBM, etc. Supplied ready to run with all cables. Standard RTB 90 day guarantee.

14" £59.00 order TD84	15" £69.00 order TG21	17" £79.00 order TJ66
--------------------------	--------------------------	--------------------------

Supplied in good used condition. Shipping code (D)

## VIDEO MONITORS

PHILIPS HCS35 (same style as CM8833) attractively styled 14" colour monitor with both RGB and standard composite 15.625 KHz video inputs via SCART socket and separate phono jacks. Integral audio power amp and speaker for all audio visual uses. Will connect direct to Amiga and Atari BBC computers. Ideal for all video monitoring / security applications with direct connection to most colour cameras. High quality with many features such as front concealed fly controls, VCR correction button etc. Good used condition - fully tested - guaranteed Dimensions: W14" x H12 1/2" x 15 1/2" D. Only £99.00 (D)

PHILIPS HCS31 Ultra compact 9" colour video monitor with standard composite 15.625 KHz video input via SCART socket. Ideal for all monitoring / security applications. High quality, ex-excellent fully tested & guaranteed (possible minor screen burns). In attractive square black plastic case measuring W10" x H10" x 13 1/2" D. 240 V AC mains powered. Only £79.00 (D)

## INDUSTRIAL COMPUTERS

Tiny shoebox sized industrial 40 Mhz 386 PC system measuring only (mm) 266 w x 88 h x 272 d. Ideal for dedicated control applications running DOS, Linux, or even Windows I Steel case contains 85 to 265 V AC 50 / 60 Hz 70 Watt PSU, a 3 slot ISA passive backplane and a Rocky 318 (PC104) standard, single board computer with 8 MByte NON VOLATILE solid state 'Disk On Chip' RAMDISK. System comprises: Rocky 318 (PC104) SBC ISA card with 40MHz AJ1 386SX CPU, 27 pin SIMM slot with 16 MByte SIMM, AMI BIOS, battery backed up real time clock, 2 x 9 pin D 16550 serial ports, EPP/ECP printer port, mini DIN keyboard connector, floppy port, IDE port for hard drives up to 528 MByte capacity, watchdog timer and PC/104 bus socket. The 8 MByte solid state 'disk on a chip' has its own BIOS, and can be ftdisked, formatted & booted. Supplied BRAND NEW fully tested and guaranteed. For full data see featured item on website. Order as QG36

100's of applications inc: firewalls, routers, robotics etc. Only £99.00 (D)

## 19" RACK CABINETS

Europe's Largest Stocks of quality rack cabinets, enclosures and accessories. Over 1000 Racks from stock

Save £££'s

This month's special  
33 / 42 / 47 U - High Quality  
All steel Rack Cabinets

Made by Eurocraft Enclosures Ltd to the highest possible spec, rack features all steel construction with removable side, front and back doors. Front and back doors are hinged for easy access and all lockable with five secure 5 lever barrel locks. The front door is constructed of double walled steel with a 'designer style' smoked acrylic front panel to enable status indicators to be seen through the panel, yet remain unobtrusive. Internally the rack features fully slotted reinforced vertical fixing members to take the heaviest of 19" rack equipment. The two movable vertical fixing struts (extras available) are pre punched for standard 'cage nuts'. A mains distribution panel internally mounted to the bottom rear, provides 8 x IEC 3 pin Euro sockets and 1 x 13 amp 3 pin switched utility socket. Overall ventilation is provided by fully hinged back door and double skinned top section with top and side louvers. The top panel may be removed for fitting of integral fans to the sub plate etc. Other features include: fitted castors and floor levelers, pre-punched utility panel at lower rear for cable / connector access etc. Supplied in excellent, slightly used condition with keys. Colour Royal blue. Some grey available - CALL - Can be supplied in many other configurations.



33U Order as BC44 External dimensions mm=1625H x 635D x 603 W. (64" H x 25" D x 23 1/2" W) Only £245

42U Order as DT20 External dimensions mm=2019H x 635D x 603 W. (79.5" H x 25" D x 23 1/2" W) Only £345

47U Order as RV36 External dimensions mm=2235H x 635D x 603 W. (88" H x 25" D x 23 1/2" W) Only £410

Call for shipping quotation

## COLOUR CCD CAMERAS

Undoubtedly a miracle of modern technology & our special buying power! A quality product featuring a fully cased COLOUR CCD camera at a give away price! Unit features full autolight sensing for use in low light & high light applications. A 10 mm fixed focus wide angle lens gives excellent focus and resolution from close up to long range. The composite video output will connect to any composite monitor or TV (via SCART socket) and most video recorders. Unit runs from 12V DC so ideal for security & portable applications where mains power not available. Overall dimensions 66 mm wide x 117 deep x 43 high. Supplied BRAND NEW & fully guaranteed with user data, 100's of applications including Security, Home Video, Web TV, Web Cams etc, etc.



Order as LK33 ONLY £79.00 or 2 for £149.00 (B)

## SOFTWARE SPECIALS

NT4 WorkStation, complete with service pack 3 and licence - OEM packaged. ONLY £89.00 (B)  
ENCARTA 95 - CDROM, Not the latest - but at this price! £7.95  
DOS 5.0 on 3 1/2" disks with concise books CW QBasic £14.95  
Windows for Workgroups 3.11+ Dos 6.22 on 3.5" disks £55.00  
Windows 95 CDROM Only - No Licence £19.95  
Wordperfect 6 for DOS supplied on 3 1/2" disks with manual £24.95  
shipping charges for software is code B

## SOLID STATE LASERS

Visible red, 670nm laser diode assembly. Unit runs from 5V DC at approx 50 mA. Originally made for continuous use in industrial barcode scanners, the laser is mounted in a removable solid aluminium block, which functions as a heatsink and rigid optical mount. Dims of block are 50 w x 50 d x 15 h mm. Integral features include over temperature shutdown, current control, laser OK output, and gated TTL ON / OFF. Many uses for experimental optics, comms & lightshows etc. Supplied complete with data sheet.  
Order as TD91 ONLY £24.95 (A)

## DC POWER SUPPLIES

Virtually every type of power supply you can imagine. Over 10,000 Power Supplies Ex Stock - Call or see our web site.

## RELAYS - 200,000 FROM STOCK

Save ££££'s by choosing your next relay from our Massive Stocks covering types such as Military, Octal, Cradle, Hermetically Sealed, Continental, Contactors, Time Delay, Reed, Mercury Wetted, Solid State, Printed Circuit Mounting etc., CALL or see our web site www.distel.co.uk for more information. Many obsolete types from stock. Save ££££'s



ALL MAIL TO  
Dept EK, 29 / 35 Osborne Rd  
Thornton Heath  
Surrey CR7 8PD, UK  
Open Mon - Fri 9.00 - 5:30

18 Million Items On Line Now!  
Secure Ordering, Pictures, Information  
VeriSign www.distel.co.uk  
Secure Site  
email = admin@distel.co.uk

ALL ENQUIRIES  
0208 653 3333  
FAX 0208 653 8888

All prices for UK Mainland. UK customers add 17.5% VAT to TOTAL order amount. Minimum order £10. Bona Fide account orders accepted from Government, Schools, Universities and Local Authorities - minimum account order £100. Cheques over £100 are subject to 7 working days clearance. Carriage charges (A)=£3.50, (B)=£5.50, (C)=£10, (D)=£15.00, (E)=£18.00, (F)=CALL. Allow approx 3 days for shipping - faster CALL. All goods supplied to our Standard Condition of Sale which can be viewed at our website and unless stated guaranteed for 90 days. All guarantees on a return to base basis. All rights reserved to change prices / specifications without prior notice. Orders subject to stock. Discounts for volume. Top CASH prices paid for surplus goods. All trademarks, tradenames etc acknowledged. © Display Electronics 2002. E & O E.

# DIY RF Inductors

## The ABCs of inductors

By B. Kainka

Electronics hobbyists often wish to copy a circuit for which suitable coils or fixed inductors are not readily available. However, you can wind just about any type of inductor if you only know how. Or you can take inductors from old equipment and modify or adjust them. All you have to do is determine is how many turns you need.



Low-value inductors are primarily used in RF circuits. A general distinction must be made between inductors with magnetisable cores (made from ferrite or iron) and 'air-core' inductors, which are wound on insulating forms or entirely without any sort of coil form.

### Air-core inductors

Let's first turn our attention to air-core inductors. **Figure 1** shows an example of an inductor for a short-wave resonant circuit, which has 20 turns, a diameter of 16 mm and a

length of 35 mm. It has an inductance of around 3  $\mu\text{H}$ , and with a variable capacitor having a maximum value of 300 pF it has lower frequency limit of approximately 5.3 MHz. How can this be calculated? Read on to learn more... (and by the way, there's also a simple utility program to make things easier).

For a 'long' inductor with  $l > D$  and  $n$  turns, a cross-sectional area  $A$  in  $\text{m}^2$  and a length  $l$  in m, the following relationship generally holds true:

$$L = (\mu_0 \times n^2 \times A) \div l$$

where  $\mu_0$  is the magnetic constant or permeability of free space and has a value of

$$4\pi \times 10^{-7} \text{ henry/metre} \\ 1.2466 \times 10^{-6} \text{ henry/metre.}$$

Although this formula is strictly true only for infinitely long inductors, it can be used as a satisfactory approximation for inductors with lengths down to  $l = D$ .

For an inductor with a given number of turns, the magnetic coupling between the individual turns increases as the length of the inductor decreases, which yields a greater inductance. By reverse token,



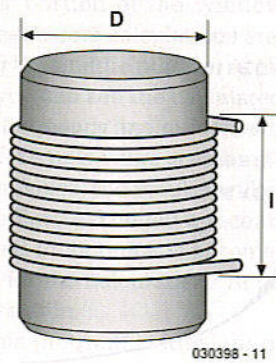

Figure 1. Structure of an air-core inductor.

increasing the spacing between the turns of an inductor decreases its inductance, and this is sometimes used to tune inductors.

For inductors having a circular cross section, the above formula can be simplified to the following approximate formula, where the diameter  $D$  and length  $l$  of the coil are given in millimetres:

$$L = n^2 \times D^2 \div l \quad [\text{nH}]$$

This formula includes the approximation  $\pi^2 \approx 10$ , which introduces a small error (approximately 1.3 %). Extreme accuracy should anyhow not be expected, since the inductance depends in part on the shape of the coil, particularly the ratio of its length and diameter, as well as the thickness of the wire and even its surroundings. Consequently, for many purposes it is adequate to be able to calculate the inductance of an air-core inductor within a 10 percent tolerance margin.

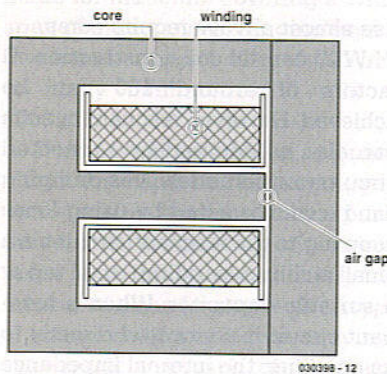

Figure 2. Structure of an inductor with an E-I core.

### Inductors with cores

RF inductor forms with threaded ferrite cores are often used in practice. The core increases the inductance, typically by a factor of four or even more. The inductor can be tuned by adjusting how far the threaded core is screwed into the inductor. Ferrite cores are made for specific frequency ranges, within which they exhibit small energy losses.

Significantly higher inductances can be obtained using closed cores with or without air gaps. Although an air gap reduces the inductance, it allows a higher magnetisation levels to be used, since it prevents the core from becoming magnetically saturated even at high currents. The types of cores commonly used are toroidal (ring) cores, E-I transformer cores (Figure 2) and closed pot cores.

With such cores, the inductance strongly depends on the material used and the geometry of the core, as well as the number of turns. This means that it is not possible to give a general formula for calculating the inductance, as with air-core inductors. Instead, manufacturers state an ' $A_L$  value' in  $\text{nH}/n^2$  for each core, such that

$$L = A_L \times n^2 \quad [\text{nH}]$$

For example, an Amidon T37-2 ring core has an  $A_L$  value of  $40 \text{ nH}/n^2$ . If you wind a coil of 10 turns on such a core, you will obtain an inductance of  $L = 4000 \text{ nH} = 4 \mu\text{H}$ .

Ring-core inductors, like air-core inductors, are suitable for building RF resonant circuits. Besides the  $A_L$  value, the design frequency range of the core is also important. Amidon Type xxx-2 cores (with red marking) are suitable for frequencies up to 30 MHz. The calculation program, which is described in more detail below, can be used to quickly determine the inductance of air-core inductors and inductors with known  $A_L$  values.

### Resonant circuits

Although resonant circuits are the most important application for inductors, resonant frequency and damping are also significant when inductors are used for other purposes. For one thing, it's important to recognise undesired resonances, and for another thing, it's very easy to determine the value of an unknown inductor by using frequency measurements.

If an inductor and a capacitor are connected together as shown in Figure 3, the result is a resonant circuit. Electrical energy can 'swing' back and forth between the inductor and the capacitor, similar to the motion of a pendulum, and such a circuit has a characteristic resonant frequency. After being excited by a short current pulse, a resonant circuit will oscillate freely at a frequency given by the formula

$$f_0 = 1 \div [2\pi \times \sqrt{LC}] \quad [\text{Hz}]$$

Resonant circuits are often used in circuits where several different frequencies are present and in frequency mixers. This allows currents and voltages to be distinguished according to their frequencies. A parallel resonant circuit has a complex impedance  $Z$  whose peak value occurs at the resonant frequency  $f_0$ . At this frequency,  $R_C = R_L$ , and the currents through the inductor and the capacitor exactly cancel each other since they have a 180-degree phase difference. An ideal parallel resonant circuit with no damping would have infinite impedance at its resonant frequency.

However, energy losses always occur in practice, due to the ohmic resistance of the coil, magnetic losses in the core of the inductor and electromagnetic radiation. The resonant impedance thus remains finite. This causes the oscillation to be damped. For sim-

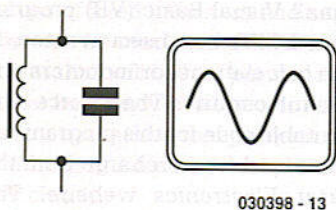

Figure 3. A inductor in a resonant circuit.

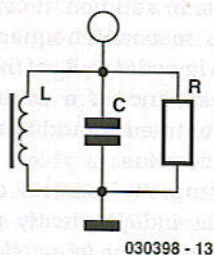

Figure 4. A resonant circuit with a loss resistor.

plicity, the losses can be grouped into an equivalent parallel 'loss resistance'  $R$ , as shown in **Figure 4**.

For every resonant circuit, it is possible to specify a quality factor, or 'Q factor', or simply 'Q', which is inversely proportional to the bandwidth of the circuit. Q is dimensionless and can easily be determined by taking the ratio of the parallel damping resistance  $R$  to the inductive impedance  $R_L = 2\pi fL$  or capacitive impedance  $R_C = 1/(2\pi fC)$  at the resonant frequency:

$$Q = R / R_L = R / R_C$$

If a resonant circuit is excited by an alternating current  $I$  with constant amplitude and variable frequency, for example using an AC generator with a high internal impedance, the voltage across the resonant circuit will be proportional to the magnitude of the complex impedance  $Z$ . The voltage will reach its maximum value at the resonant frequency.

The amount that the voltage increases at resonance is inversely proportional to the extent to which the oscillations are damped by any sort of energy loss, and thus directly proportional to the Q factor of the resonant circuit. At either side of the resonant frequency, points can be found at which the voltage is reduced from its maximum value by a factor of  $1/\sqrt{2} = 0.707$  (-3 dB). The difference between the frequencies of these two points is defined to be the bandwidth  $BW$  of the circuit. The relationship between the bandwidth  $BW$  and the resonant frequency  $f_0$  and Q factor of the circuit is:

$$BW_{(-3dB)} = f_0 / Q$$

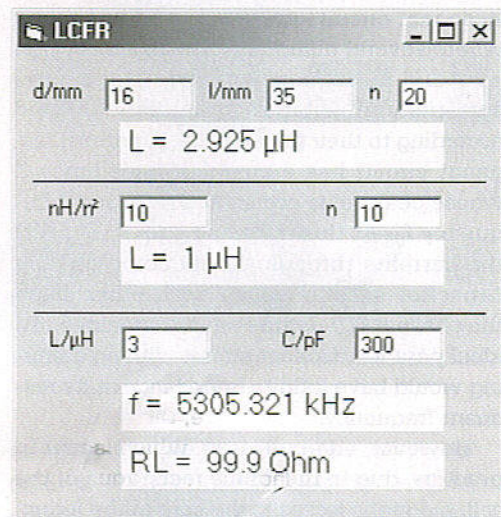

Figure 6. User interface for the inductor calculation program.

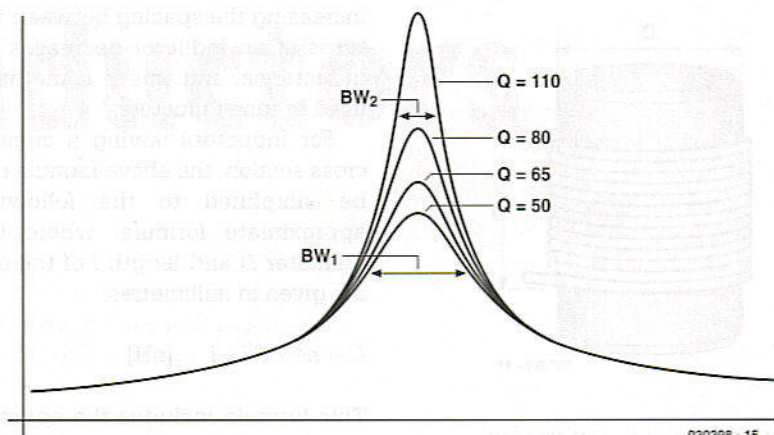

Figure 5. Resonance curves with various Q factors.

**Figure 5** shows resonance curves for several different Q factors. A circuit with  $Q = 50$  has a greater bandwidth ( $BW_1$ ) than one with  $Q = 110$  ( $BW_2$ ). You can also see that the peak value at resonance increases as the Q factor increases. This means that the resonant circuit oscillates more strongly at its resonant frequency. By contrast, the various circuits show nearly the same behaviour in regions far away from the resonant frequency.

In practice, the circuit damping, and with it the Q factor, almost always arises from a combination of series and parallel resistances. The series resistance comes from the wire used to form the coil, and at a given frequency it is greater than the DC resistance of the inductor, due to the 'skin effect'. The parallel resistance is determined by the matching impedance in the circuit. However, iron cores and ferrite cores also have losses that can be expressed in the form of a parallel resistance. For a given inductance, an inductor with a core requires fewer turns and thus has smaller copper losses, but this comes at the price of core losses.

At high frequencies (above approximately 100 MHz), pure air-core inductors wound using thick, silver-plated wire give the best results, while at medium frequencies (around 10 MHz) the best Q factor can be obtained using closed cores, such as ring cores. However, air-core inductors can also be used down to frequencies of approximately 1 MHz. By contrast, inductors and transformers for use at low frequencies

use almost always require cores.

With careful coil construction, Q factors of around 100 can be achieved. However, resonant circuits can also be damped by connected circuitry or an aerial. This damping can be counteracted by using loose coupling to the resonant circuit via a small auxiliary winding, a coil tap or a suitable capacitor. When a resonant circuit is connected directly to an amplifier, the internal impedance of the amplifier must be very high in order to minimise the damping.

## Inductor calculations using software

A small Visual Basic (VB) program called **LCFR** has been written to make calculations for inductors and resonant circuits. The source and executable code for this program can be obtained free of charge from the *Elektor Electronics* website. The number is **030398-11**, see this month's Free Downloads. This program, whose user interface is shown in **Figure 6**, calculates the inductance of air-core inductors and inductors using cores with known  $A_L$  values. In addition, it can determine the resonant frequency and inductive impedance  $R_L$  of the inductor at resonance if a capacitance value is entered in addition to the inductance value.

The program consists of three parts that independently perform calculations, which for purely practical reasons are merged into a single user interface. Calculations for air-core inductors are made using the

upper portion of the window, and magnetic-core calculations are made using the middle portion. At the bottom you can see the calculated resonant frequency and inductive impedance. If a new value is entered in any of the boxes, the results will change immediately. The most recently calculated inductance is automatically used for the calculations in the bottom section.

This program is ideal for quickly 'trying out' new parameters. The fact that the inductance is shown to three decimal places should not be taken as an indication of the accuracy of the result. Instead, it is intended to allow calculations to be made for inductors covering a wide span of inductances, ranging from a few nanohenries ( $1 \text{ nH} = 0.001 \mu\text{H}$ ) to many millihenries ( $1 \text{ mH} = 1000 \mu\text{H}$ ).

If you want to build a resonant circuit for a specific frequency, you can start by entering the capacitance, then calculating the inductance and finally determining the number of turns for a type given type of core or coil form. However, a less systematic approach often works better. You can simply select a type of inductor and then try several inductance and capacitance values until you find a satisfactory result. For instance, you may wish to determine which standard component values of fixed inductors and capacitors can be used to build a resonant circuit that will have a particular resonant frequency in a specific circuit. Here a trial-and-error approach often yields results faster than systematic calculation.

### Some practical examples

Suppose you want to wind a  $330\text{-}\mu\text{H}$  inductor for a medium-wave detector radio on a cardboard roll with a diameter of 42 mm. Further suppose that the wire diameter is 0.5 mm, so 100 turns will yield a coil length of 50 mm. Now you can simply try several different values, which ultimately yields a result of approximately 80 turns. For tuning the medium-wave (MW) band starting at 530 kHz, the variable capacitor must have a maximum capacitance of at least 45 pF.

For higher frequencies, you will

need fewer turns. An inductor for a VHF FM receiver, for example, will have only five turns, with  $D = 8 \text{ mm}$  and  $l = 10 \text{ mm}$ . The calculated inductance is  $0.16 \mu\text{H}$ . With a  $20\text{-pF}$  capacitor, this inductor will resonate at 88.9 MHz, which is almost exactly the lower limit of the VHF FM broadcast band.

The above examples use air-core inductors. But how can you use a ferrite core? Usually, you won't have any exact data for the core. You will thus have to estimate how much it will increase the inductance or reduce the frequency. An inductor for the short-wave band, for example, might have  $n = 18$  turns,  $D = 8 \text{ mm}$  and  $l = 12 \text{ mm}$ . For a pure air-core inductor, this gives a calculated inductance of  $1.7 \mu\text{H}$ . But with a  $275\text{-pF}$  variable capacitor, this inductor achieves a lower frequency limit of approximately 5 MHz with the core fully threaded in, which corresponds to an inductance of approximately  $3.7 \mu\text{H}$ .

The frequency can thus be reduced by a factor of two using a threaded core, and the inductance can be up to four times as large. A relatively long medium-wave ferrite rod can in turn increase the inductance by a factor of approximately ten. Roughly speaking, we can say that an inductor on a ferrite rod only needs to have approximately one third as many turns as a similarly dimensioned air-core inductor having the same inductance.

The resonant frequency of a resonant circuit can change considerably when it is built into a circuit. Particularly at relatively high frequencies, wiring capacitances have a significant effect. This means that it is often necessary to make adjustments after assembly or build tuning capability into the circuit by means of a threaded core or trimmer capacitor.

For major modifications, it is often helpful to use a few rules of thumb that can be directly derived from the formulas given above and simulated using the LCFR program. For instance, doubling the number of turns quadruples the inductance and cuts the frequency in half if the capacitance remains the same. The frequency is thus inversely proportional to the number of turns and

inversely proportional to square of the capacitance. This means that twice the frequency can be attained with one fourth of the capacitance. In order to tune over a frequency range of 1:3 using a variable capacitor, you need a capacitor with a capacity ratio of at least 1:9.

Inductors are not necessarily limited to RF circuits. They are also used in interference filters, low-frequency/audio filters and voltage converters. Schematic diagrams often show only the inductance value, without any other data for the inductor. Particularly in blocking-type voltage converters, the saturation current level and resistance of the inductor are also important factors.

It is also certainly possible to use a fixed inductor with the correct inductance but still not obtain the optimum result. Consequently, it is often worthwhile to wind your own inductors, even if only for initial testing. For instance, a  $1.5\text{-mH}$  inductor for a voltage converter can be wound on a ferrite rod from an old medium-wave radio. If you have a relatively small ferrite rod that originally had 100 turns (which can be easily counted when you unwind the coil), it must have had an inductance of  $300 \mu\text{H}$ , since the commonly used variable capacitors have a maximum capacitance of approximately 300 pF. You can thus calculate an  $A_L$  value of  $30 \text{ nH/n}^2$ . From here it's only a small step to the desired result: you will have to wind approximately 220 turns on the rod to obtain 1.5 mH.

### Damping, Q and bandwidth

If you know the value of the damping resistance for a resonant circuit, it's easy to calculate the circuit's Q factor, and thus its bandwidth. This following example shows how a specific problem can be solved using the LCFR program.

Suppose you want to build an aerial filter for the medium-wave frequency of 1296 kHz (BBC, AM and DRM) using a fixed inductor. A possible solution can be found using the standard values of  $100 \mu\text{H}$  and  $150 \text{ pF}$ . The program calculates a resonant frequency of 1299.5 kHz, and the small deviation of 3.5 kHz lies within the allowed tolerance. The program also indicates an inductive impedance of approximately  $800 \Omega$ .

If the DC resistance of the inductor ( $1.7 \Omega$ ) is taken as the series resistance and divided by the inductive impedance, the resulting Q factor is approximately 500, which is unrealistically large. In actual fact, you should assume a Q factor of around 50 for small fixed inductors. The extra damping arises from the skin effect and core losses.

In order to avoid excessive loss of energy

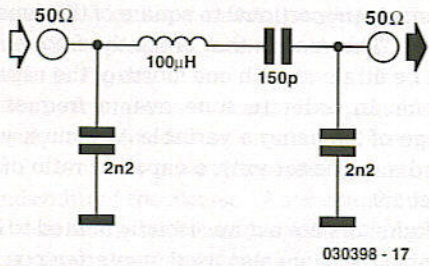

Figure 7. A filter circuit.

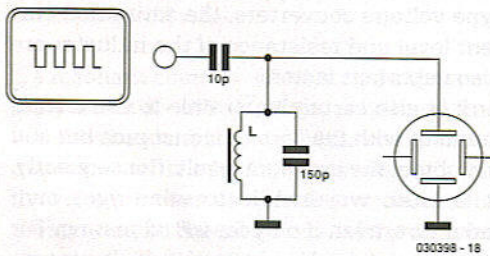

Figure 8. Exciting free oscillations.

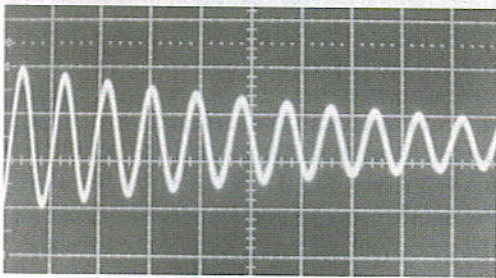

Figure 9. Damped self-resonant oscillations.

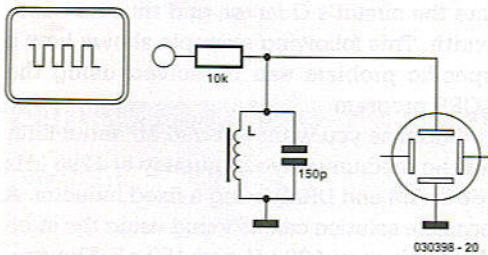

Figure 10. Resistive coupling

from the aerial, the filter should primarily be damped by the connected circuit. We thus chose a low working value of  $Q = 10$ . This also means that there's a reasonable chance that frequency deviations due to component tolerances will lie within the bandwidth of 130 kHz. A  $Q$  factor of 10 can be obtained with a parallel resistance of 8 k $\Omega$ .

If the aerial input of the receiver has an impedance of 50  $\Omega$ , an impedance conversion

ratio of 160 is necessary. This corresponds to a voltage conversion ratio of  $\sqrt{160} = 12.6$ . If you used an inductor that you wound yourself, you could achieve this using a suitable tap or coupling coil. For a resonant circuit using a fixed inductor, a capacitive voltage divider can be used. The initial form of the resulting circuit is shown in **Figure 7**.

The actual resonant frequency has now been increased slightly, since the capacitance of the resonant circuit has been reduced by the two additional capacitors. You could thus suitably modify the values of the capacitors or provide a supplementary trimmer. However, it may be better to first try out the circuit. It may well be that the self-capacitance of the fixed inductor partially compensates for this error. In fact, this circuit proved to be satisfactory in practice in a DRM receiver without subsequent adjustment.

Would it be possible to use a T37-2 ring core with  $A_L = 4$  nH/n<sup>2</sup> to make a DIY inductor? This idea can be quickly simulated and equally quickly rejected, since 158 turns is an unrealistic value for a small ring core. However, an air-core inductor with  $D = 8$  mm,  $l = 8$  mm and 110 turns is conceivable. If you have a suitable threaded core, you can manage with approximately half as many turns. This also allows the exact frequency of the filter to be adjusted using the core.

## Measurements

If you do not have a suitable signal generator or dip meter, the only way to measure the resonant frequency of a resonant circuit is to use an oscilloscope. The frequency can be measured by exciting the circuit so it oscillates freely (**Figure 8**).

This requires a steep-edged square-wave signal with a frequency well below the resonant frequency. Many oscilloscopes have a square-wave output for calibration purposes (usually 1 kHz). This should be coupled to the resonant circuit as loosely as possible via a small capacitor. With suitable adjustment of the time base, you will be able to observe free oscillations. Besides the resonant frequency, damping can also be measured in this manner.

**Figure 9** shows a measurement made using the previously calculated resonant circuit. What is important is to affect the circuit as little as possible. This means you should use a 10:1 probe with an internal impedance of 10 M $\Omega$ . The figure shows the result of a measurement made with a horizontal deflection factor of 1  $\mu$ s/division. The measured frequency is slightly greater than 1100 kHz.

The  $Q$  factor can be determined from the number of oscillations required for the amplitude to drop to 0.37 (1/e) of the initial value. Here the  $Q$  factor is approximately 10.

The frequency and  $Q$  factor are affected by the measurement set-up. However, they will be affected even more strongly in an actual circuit.

A 10-k $\Omega$  coupling resistor can be used instead of a 10-pF coupling capacitor (**Figure 10**). In this case, the resulting oscillations will be somewhat weaker, so a more sensitive vertical scale must be selected. Using a resistor for coupling generates higher damping. However, the advantage of this approach is that it avoids any shift in the resonant frequency due to the coupling capacitor, so the frequency can be measured more accurately. In addition, measurements can also be made over a wide frequency range, from around 10 kHz to many megahertz.

This simple measurement technique can also be used to measure the values of unknown inductors. If you use a known capacitance value and measure the frequency, you can then determine the inductance. It is often necessary to try several different capacitors before you obtain readily measurable oscillations. With relatively large inductances, it is necessary to use correspondingly large capacitors. It is also possible to determine the value of an unknown capacitor using a known inductance.

The  $A_L$  values of unknown cores can also be determined using this technique. To do this, wind a small test coil on the core and determine the resonant frequency with this coil connected to a known capacitor. From the number of turns and the inductance, you can then determine the approximate  $A_L$  value.

(030398-1)



# Simple 12-to-230V Power Inverter

A mobile power outlet

Design by G. Gerards

[www.aixcon.de](http://www.aixcon.de)

The absence of a mains power outlet is often keenly felt on camping sites, with car repairs in the middle of nowhere and with picnic or party events in the countryside. In some cases, mains power can only be brought to a remote site by running a very long cable — which either dangerous, impossible or not available. Whatever the occasion, planned or unexpected, it is great to have a power inverter available capable of changing the 12-V car battery voltage into 230 volts AC.

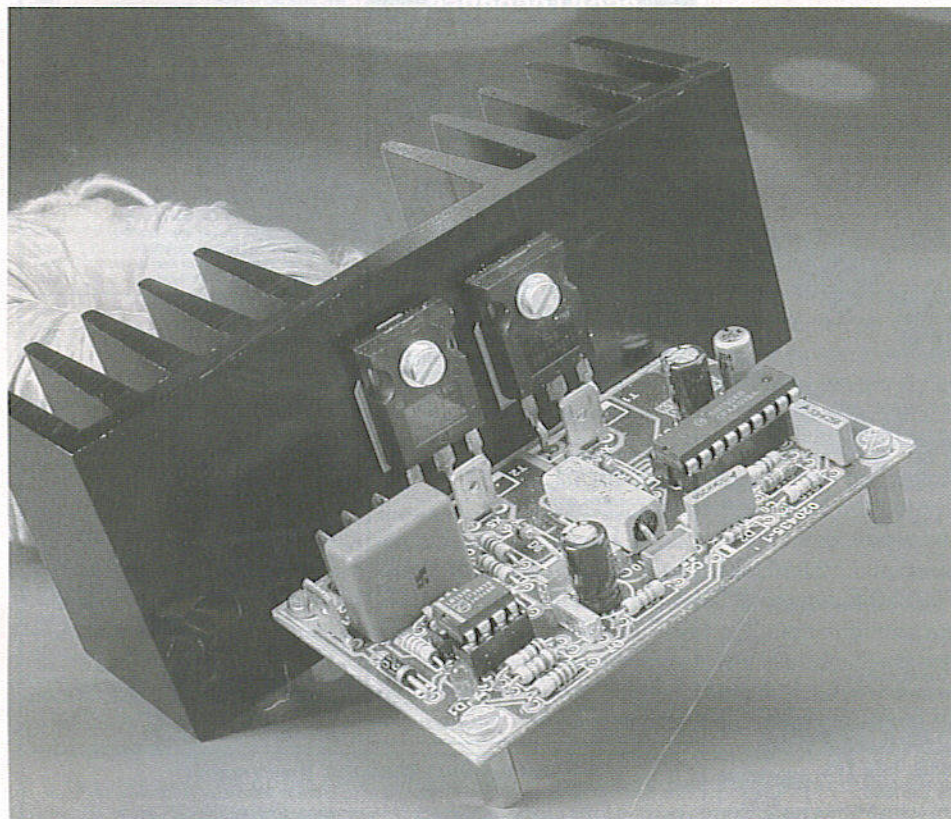

The idea for a simple, portable 'power outlet' was first suggested by a trainee at the Aixcom company, which is normally involved with high-tech power inverters and special high-current power supplies. The trainee, called Dirk, had been trying for quite some time to build a power inverter for his model aircraft club. In his enthusiastic attempts he ran into problems obtaining the special integrated circuit that was to form the heart of his project. When he was finally successful in obtaining the elusive chip, albeit at horrific costs, all the circuit did was produce a loud bang at switch-on, wrecking a lot of components.

The company decided to continue the design, and the result is presented here: a power inverter that was not only successfully reproduced by nearly all trainees at Aixcom, but also presented as a Christmas or anniversary gift to dad, used on a camping site and, last but not least, deployed in a (very loud)

music parade. A beefed up version of 1,000 watts was developed and installed by Dirk at his model aircraft club, where it has performed beautifully for over a year despite rough conditions.

### Concept

Arguably, the circuit represents the simplest way of creating a power outlet for on the road. In the design phase, the aim was a 100% bare bones circuit, stripped of anything that could be, well, stripped! For example, there's no voltage regulation, and a sagging battery voltage also causes the ac output voltage to sag. However, because most mains powered equipment continues to work just fine in the face of ac voltage variations of  $\pm 10\text{-}15\%$ , the mobile power outlet does so too. Rather than perfecting the design for performance, Aixcom went for simplicity, low component count and utter reliability in practical use. None the less, the 230-Vac output is short-circuit resistant and an undervoltage protection switches the inverter off before the battery has been drained to level that would no longer allow the car to be started. The circuit is simple enough to be reproduced successfully by beginners, too, provided they realise that 230 Vac is a really dangerous voltage.

### Pulsewidth modulation

The central part in the circuit is an SG3526 low-cost switch-mode regu-

lator, which is supplied by a number of manufacturers under the component identifier xx3526, where xx is a manufacturer-specific letter combination. The 3526 supports all known switch-mode PSU topologies. Its complete datasheets may be obtained free of charge from [www.unitrode.com](http://www.unitrode.com) (part search: UC3526 and Datasheet).

The basic operation of the power inverter is illustrated in **Figure 1**. The SG3526 alternately switches the current through the 12-V windings of a mains transformer, the two central ends of the windings having been taken together and connected to the positive battery terminal (+12 V). At each switching action, the direction of the current changes and with it the direction of the magnetic field in the transformer core. The result is a square-wave(-like) alternating voltage at the 230-V side of the transformer.

In real life, the switch consists of two FETs in complementary arrangement (push-pull). The source connections of the FETs are taken to ground by way of very low resistances (compare the circuit diagram in **Figure 3**).

The internal architecture of the SG3526 is shown in **Figure 2**. The input voltage  $+V_{in}$  may be between 7 V and 35 V, and is used to create a reference voltage  $V_{REF}$  of 5 V. A voltage guard blocks the drivers stages when the input voltage drops below 7 V. The drivers are separately powered via the  $+V_C$  connection. Using resistor  $R_T$  and the capacitor at CT

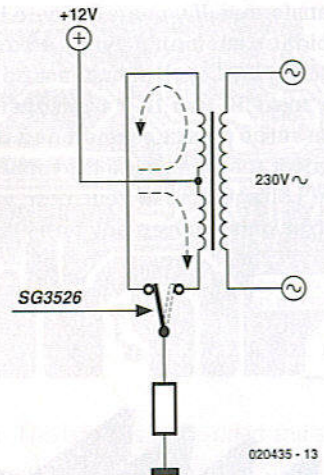

Figure 1. Block diagram of the power inverter. In the actual circuit, the switching element consists of two power FETs, while the resistor to ground acts as a current sense (shunt) for the current limiter circuit inside the SG3526.

(again compare with circuit diagram in **Figure 3**) the frequency is determined, which is 50 Hz in this case. The resistor at  $R_D$  causes a fixed dead time between the driver's Output A and Output B. This is done to eliminate the risk of the two drivers (and consequently the two power FETs) conducting at the same time when the switch-over takes place.

The capacitor at the  $C_{SOFTSTART}$  pin ( $C_{SS}$ , pin 4) allows the pulse mark/space (on/off) ratio of the outputs to be slowly raised to 48% after the supply voltage is switched on, or after a reset. The 'Amp' voltage regulator is not used as such in our application, alternatively it takes the role of an impedance converter using the reference voltage as the controlling quantity. In this way it is assured that the outputs supply the full mark/space ratio after the start-up phase.

The current limiter using shunt resistor  $R_8$  triggers a shutdown sequence when the voltage between  $+CS$  and  $-CS$  (in other words, the drops across  $R_8$ ) exceeds 100 mV. However, the shutdown control may also be used externally by connecting it to ground. Because shutdown and Reset (pins 8 and 5 respectively) are interconnected in this circuit, the modulator starts again with a soft start after an overload condition or an external disconnect.

### More design thoughts

The transformer for the project should be a toroidal type with a primary of 230 V and two 12-V secondary windings. Readers in countries with 110 V, 117 V or 127 V mains voltage are, of course, advised to use a matching 200-

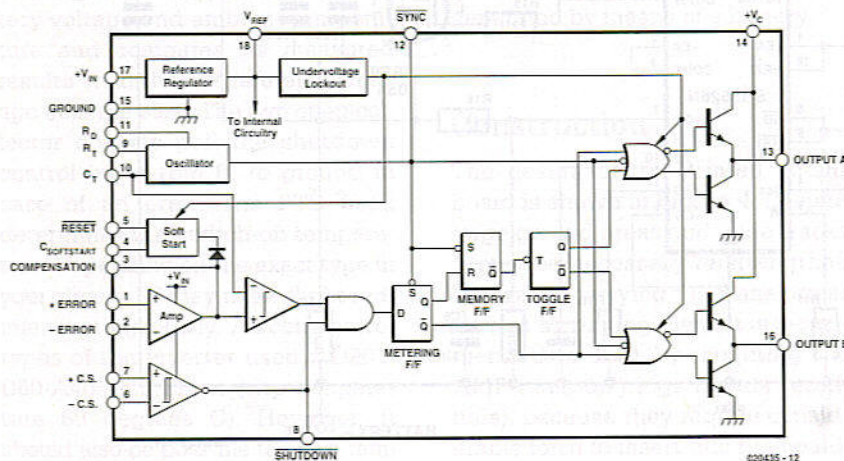

Figure 2. Internal diagram of low-cost SMPSU regulator type SG3526.





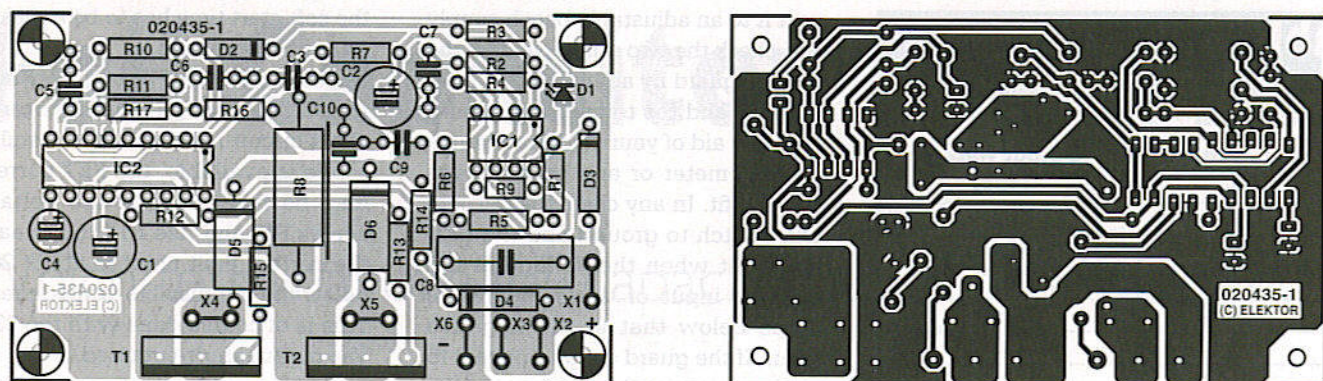

Figure 4. Copper track layout and component mounting plan of the PCB designed for the project. The board is single-sided and available ready-made through Readers Services.

using a smaller value for shunt R8 and/or by modifying voltage divider R16-R17.

Ordinary bulbs and halogen (flood-) lights are sure sources of trouble with most power inverters. Both present a very low 'cold' resistance, causing the inverter to reduce its output voltage or even actuate the shutdown. The result is a lock-up with insufficient voltage to heat up the filaments to their normal operating temperature. Fortunately, the 200-watt version of the inverter described here should be capable of turning on lamps of up to 150 watts without problems. Should problems arise, the value of capacitor C6 may be increased — but not to any extent because the ability of the circuit to withstand short-circuits may well suffer. Using C5 it is also possible to increase the soft-start time considerably, or do without it altogether. That, in all likelihood, is the safest solution.

Comparator IC1 monitors the battery voltage and ambient temperature and compares its measured results with the 5-V reference voltage from the 3526. The two open-collector outputs pull the shutdown control input (pin 8) to ground in case of an error. The PTC used determines the switch-off temperature. Depending on the exact type in your circuit, R6 may need slight redimensioning. Early Aixcom prototypes of the inverter used a D901-D60-A40 from Epcos (trip temperature 60 degrees C). However, it should also be possible to use a temperature switch of 60 to 80 degrees C or a temperature fuse of

90 degrees C. Although the latter component is extremely cheap at just a few pence, you'll need to exchange it when it has 'gone off'.

Provided a large enough heatsink is used, a simple wire link may be used instead of the PTC. The voltage monitor switches off at about 12 volt and this may be adapted to suit other levels by changing R1 and R5. On the comparators, R2 and R4 define an amount of hysteresis that prevents the power inverter from switching itself on again after a fault condition. After switching on, the reference voltage rises slowly as determined by the charge time of C2, hence the monitors are only activated a few seconds later.

**Car batteries supply dangerously high currents.** To prevent the inverter going up into flames and causing a fire, you **must** protect it with a car fuse of between 25 A and 35 A. The 230 Vac output voltage is also **very dangerous** even if it is generated by means of a battery.

## Construction

The design of the printed circuit board is shown in **Figure 4**. Despite large ground areas and wide tracks it may be necessary to strengthen the tracks carrying the transformer current by tinning them. It is recommended to start by mounting the AMP ('fast-on') lugs (spade terminals), because they require considerable force to insert into the board. After all, a mishap with the use of pliers at this point could cause con-

## COMPONENTS LIST

### Resistors:

- R1 = 15k $\Omega$
- R2 = 22k $\Omega$
- R3 = 2k $\Omega$ 7
- R4 = 10k $\Omega$
- R5 = 12k $\Omega$
- R6 = 4k $\Omega$ 7
- R7 = 47k $\Omega$
- R8 = 0 $\Omega$ 201 (max. lead pitch 24mm)
- R9 = 1k $\Omega$  (PTC, see text)
- R10 = 8 $\Omega$ 2
- R11 = 16k $\Omega$ 9
- R12 = 33 $\Omega$
- R13,R15 = 22 $\Omega$
- R14 = 18 $\Omega$
- R16 = 1k $\Omega$
- R17 = 470 $\Omega$

### Capacitors:

- C1,C2 = 220 $\mu$ F 16V radial
- C3,C7,C9,C10 = 220nF
- C4 = 1 $\mu$ F 63V radial
- C5,C6 = 33nF
- C8 = 2 $\mu$ F2 63V, 15mm lead pitch, MKS4 (Wima)

### Semiconductors:

- D1 = LED, red, low current
- D2 = 1N4148
- D3 = 1N4002
- D4 = 18V 1.3W zener diode
- D5,D6 = BYV27-200
- IC1 = LM393N
- IC2 = SG3526N
- T1,T2 = IRFP054N (IRF)

### Miscellaneous:

- X1-X6 = AMP spade terminals, PCB mount
- PCB, order code **020435-1** (see Readers Services page)
- Toroidal mains transformer, see text, e.g., Aixcon 230V / 12-0-12 V / 200W ([www.geist-electronic.de](http://www.geist-electronic.de))

## Table 1

Output voltage vs. battery voltage  
(150 watt load)

Battery voltage [Vdc]	Output voltage [Vac]
11.5	182.4
12	194.6
12.5	202.4
13	214.3
13.5	223.0
14	231.2

siderable damage to other components on the board. The wire link beside the shunt resistor R8 should not be forgotten. R8, by the way, should be mounted a little above the board surface to help it stay as cool as possible. If desired a higher-wattage resistor may be substituted (5 watts). Finally, do make sure you mount all polarised components (transistors, electrolytic capacitors, diodes and ICs) the right way around on the board. Insulating washers must be used when fitting the transistors onto the heatsink.

### Powering up

Commissioning this project only requires a multimeter. Initially, you use the inverter without the transformer connected. Con-

nect it to an adjustable bench supply and check the two guard circuits: the voltage guard by adjusting the input voltage, and the temperature guard with the aid of your soldering iron, a potentiometer or any other means you see fit. In any case, the outputs will switch to ground and the LED will light when the voltage at the positive input of the comparators drops below that at the negative input. If the guard circuit appears to work, you proceed by measuring the two gate signals. If an error is present, both will read 0 V. In the case of an error-free circuit, an oscilloscope will show two clean rectangular-wave signals with 10-ms long pulses. Using your multimeter, the same measurement yields a readout of about half the supply voltage.

All approved so far, you are in a position to connect the toroidal transformer. At this point, it makes sense to remove IC1 from its socket, as in that case the shutdown can only be triggered by the current limiter. If an ordinary 100-watt bulb does not light up within a few seconds, measure the voltage at the shutdown control (pin 8 on the 3526 or the anode of D2). If you measure less than 5 V, the current limiter or

the soft-start time has to be tweaked as described above.

Once the bulb lights, you may (carefully!) check if the inverter is short-circuit resistant. If an oscilloscope is available, the FET current may be measured (= the voltage across R8) and use R16 to increase the current limit point to about 20% below the permissible drain current. This is of course done with the 230-Vac output short-circuited.

It is normal for the transformer to make more noise under no-load conditions than you would expect when in normal use. This is caused by the rectangular wave switching the magnetic field hard and fast. Core saturation under no-load conditions is signalled by ugly sounds from the transformer. Measured with an oscilloscope the currents will not rise in sawtooth-wise but with peaks (overshoot). In that case, the 12-V windings on the transformer require just a few more turns. If that is problematic, the alternative is to raise the oscillator frequency a little by using a slightly lower value for R11. The resulting output frequency may well be 55 Hz, but that is immaterial for most loads and the circuit is not suitable anyway to power an alarm clock.

### Practical results

Because a voltage regulation loop omitted for the sake of simplicity and cost, the output voltage is dependent on the battery voltage. The output voltage of the author's prototype loaded with a 150-watt halogen lamp is shown in Table 1, as a function of battery voltage.

The output voltage is dependent on the transformer's winding ratio and output current. If you want to reach the nominal output voltage of 230 Vac at 13 Vdc input, you should consider using a transformer with two 11-volt windings. On the prototype, a maximum efficiency of 94% was measured and the circuit was found to be DirK-proof.

(020435-1)

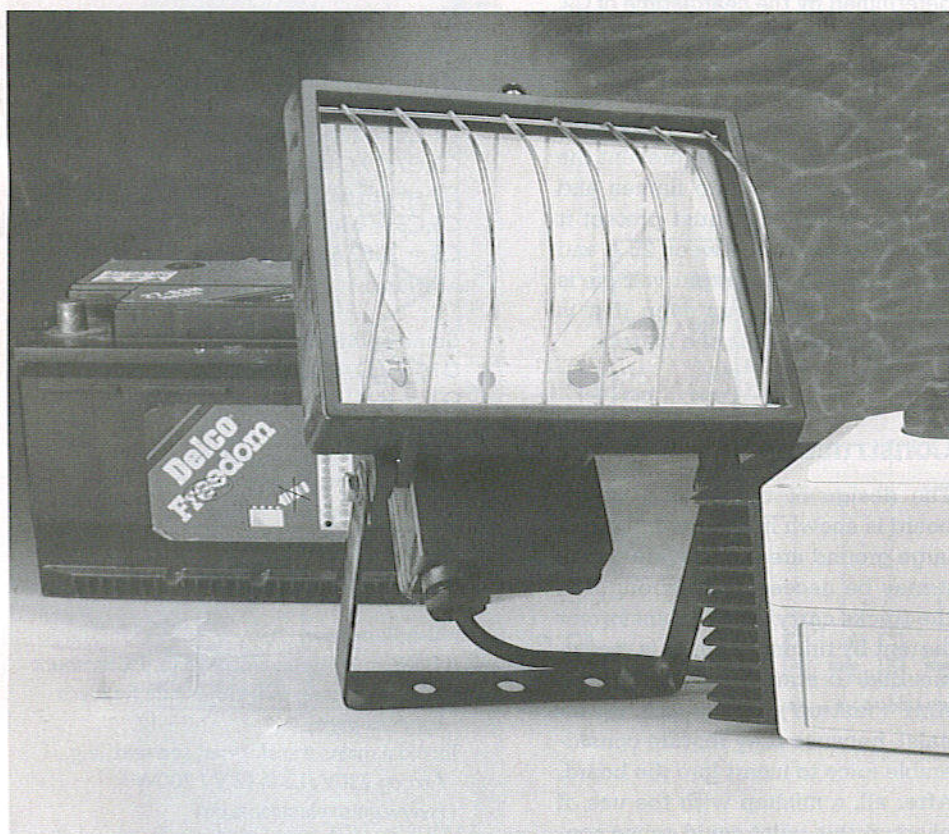

# Foil Capacitor Polarity

## Which terminal of a foil capacitor acts as the screen?

By H. Friedli

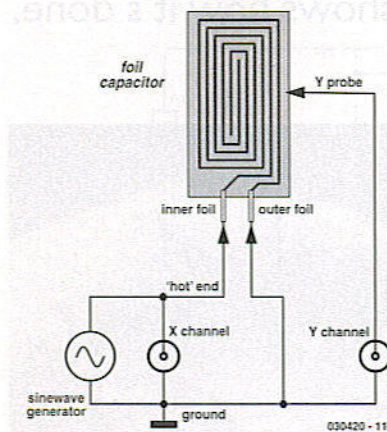

Figure 1. Method of connecting a foil capacitor to a sinewave generator and an oscilloscope.

As most of you will be able to confirm, an electrolytic capacitor has to be connected the right way around in an electronic circuit. If you get the connections wrong, the innards of the capacitor will greet you when the power is switched on — the capacitor can will rupture, spilling its liquid or partly vaporised contents across the circuit board or (in the case of older high-voltage electrolytics) spouting it high up into the air. The rupture is not a silent process either as most of you will have learned the hard way. Depending on the size of the capacitor, a small explosion may occur. By contrast, fixed capacitors are non-polarized components and therefore not prone to explode unless they are operated way beyond their specifications in respect of voltage or surge current.

The is however one type of fixed capacitor that may still be qualified

as 'polarised'. We're talking about foil capacitors, which can pick up noise when connected the wrong way around. This may affect the operation of sensitive electronic circuits like preamplifiers, the negative effects consisting of hard to explain levels of hum or cross-talk, or a tendency to oscillate. Take, for example, the wire of the coupling capacitor connected to the (very high-impedance) input grid of a valve. This particular wire must be connected to the inner foil of the coupling capacitor, the outer foil being connected to the anode of the driving valve, which represents a much lower impedance.

With many types of capacitor, the outer foil is marked by, for example, a dash, a dot or some other indication. Unfortunately this is not common practice among manufacturers and even the print on the capacitor may not always provide a definitive clue to how the foils are arranged inside the device.

### Trick of the trade

A simple trick is available that allows you to relate the capacitor wires to the rolled up foils inside. A sinewave voltage is applied to the capacitor as well as to the X (horizontal) input of a dual-trace oscilloscope. The test signal should have a frequency of about 1 kHz and a level of a couple of volts peak to peak. The probe connected to the Y channel is held close to the capacitor's plastic encapsulation. On the 'scope display you watch the amplitude changes in a very sensitive input range. With the 'scope set to X-Y mode, a more or less opened, widened or possibly

sloping ellipse should be seen. If the ellipse widens in the Y direction when the probe is moved closer to the capacitor body, the outer foil is connected to the 'hot' (signal) end of the generator output. If it becomes narrower, the same foil is connected to the ground. To verify the outcome, swap the capacitor connections and repeat the test.

If you are unable to see a clear shape change to the ellipse, either the signal voltage or the test frequency is too low, the Y channel is not sensitive enough or the effect of your hands is too large. By fitting the tip of the Y probe with a small disc results in a larger capacitance between the outer foil and the Y-channel input. This may help to improve the reliability of the test described above.

Once you've unequivocally identified the connections that go with a capacitor's inner and outer foil, that does not mean the outcome can be applied to other, identical capacitors! The author found inconsistencies even among capacitors from a batch produced by one of and the same (reputable) manufacturer. In practice, each foil capacitor has to be tested individually if you want to be absolutely sure where its wires are best connected to in your circuit.

(030420-1)

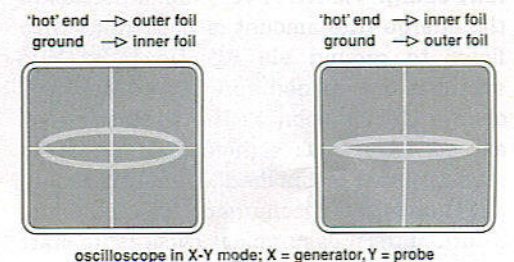

Figure 2. Left: wrong polarisation; right: correct polarisation.

# Touch-controlled Switch

## With a PIC

Design by J. Wickenhäuser

www.wickenhaeuser.com

You don't need special ICs when a capacitive (or 'touch') switch can also be realised with an inexpensive PIC controller. This article shows how it's done.

Over the past few years several manufacturers have come up with special integrated circuits for touch control switches. These ICs usually operate on the principle of capacitive change, work perfectly but are hard to obtain as well as relatively expensive. Fortunately, a capacitive switch may also be realised using 'traditional' means, i.e., a little physics and a microcontroller.

### The human body

may act as one plate of a capacitor, with the other plate formed by a coin soldered onto a copper plane. The principle is illustrated in **Figure 1**. Assuming the coin has a surface area of  $3.2 \text{ cm}^2$  and is placed at a distance of 4 mm (using an acrylic plastic disc as a spacer) and a dielectric constant of 8, a theoretical capacitance of 8 pF is obtained, or 2-3 pF when the pad is not touched.

A second capacitor (C2) is charged via two resistors. In reality, the three switches are microcontroller port lines with GP1/GP2 representing signal 'A' and GP0, signal 'B'.

The measurement comprises the closing of the two switches for  $2 \mu\text{s}$  using signal 'B'. The  $2\text{-}\mu\text{s}$  period allows capacitor C1 to almost fully charge via R1. A very small portion of the charge (the amount is negligible) also flows to ground via R2. Next the two switches are opened and C1 is allowed to charge C2. As soon as the voltage on C2 exceeds a certain level (here, about 0.7 V) the measurement is finished. Signal 'B' disappears and C2 is discharged. This marks the return of the measurement cycle to its start state. The number of iterations it takes to fully charge the second capacitor is counted — it's as simple as that.

The simultaneous charging and discharg-

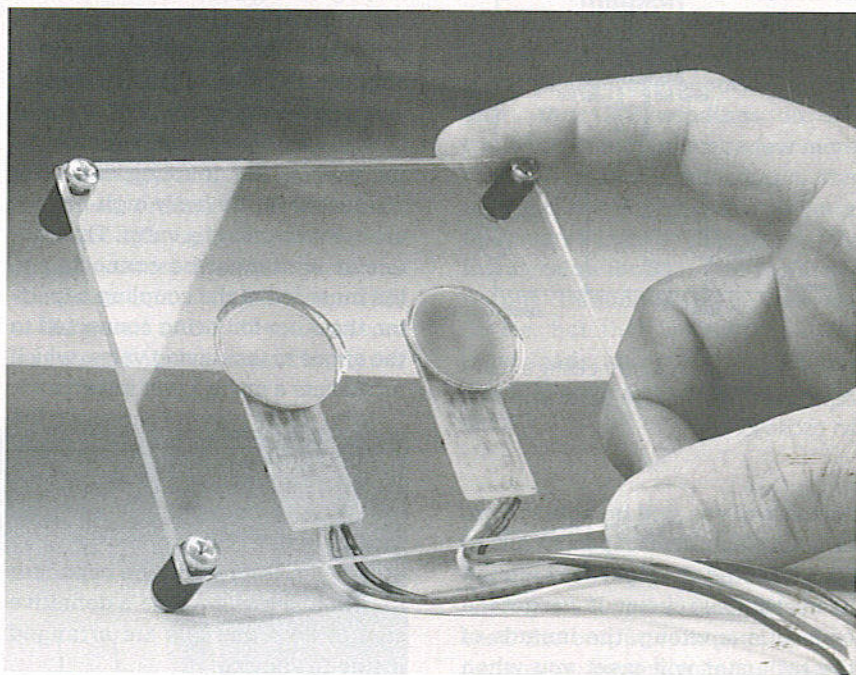

ing of C2 may appear a bit of a contradiction. However, a small portion of the charge in C2 is also lost, because the switches are open much longer than closed.

### The smart button

Ideally, about 20,000 cycles are required to enable C2 to be charged by the user's finger. Consequently a measurement takes about 50 ms. As soon as the software has recognised a 'key press' action on GP3, output GP4 is pulled Low, causing the indicator LED to light up. At the same time, the number of cycles for each

measurement is output via pin GP5. An oscilloscope or a pulse counter connected to GP5 will clearly indicate the approach of the finger.

As you can see from the circuit diagram in **Figure 2**, the microcontroller used is a cheap and easy to obtain type PIC12C508 which has 512 bytes of memory. If you happen to have a '509 lying around (with 1024 bytes) it can be used also. The R-C oscillator inside the PIC operates at about 4 MHz.

The printed circuit board shown in **Figure 3** is single-sided. Normally the copper plane on the board is sufficient for reliable operation. In cases

## Free Downloads

PIC source code for use with Microchip MPLAB assembler.

File number: 030214-11.zip

PCB layout in PDF format.

File number: 030214-1.zip

[www.elektor-electronics.co.uk/dl/dl.htm](http://www.elektor-electronics.co.uk/dl/dl.htm), select month of publication.

## COMPONENTS LIST

### Resistors:

R1,R6 = 10kΩ (SMD shape 0805)

R2,R3,R4 = 100kΩ (SMD shape 0805)

R5 = 1kΩ (SMD shape 0805)

R7 = 470Ω (SMD shape 0805)

### Capacitors:

C1 = 470nF (SMD shape 1206)

C2 = 100nF (SMD shape 0805)

### Semiconductors:

D1 = Chip LED, red, (SMD shape 0805)

T1 = BC847 (SOT23 case)

IC1 = PIC12C508A04/SO8, programmed, order code **030214-41**

### Miscellaneous:

K1 = 4-way mini PCB terminal block, lead pitch 2.5mm

PAD = sensor area (see text)

PCB, order code **030214-1**

Disk, PIC source code file, order code **030214-11** or Free Download

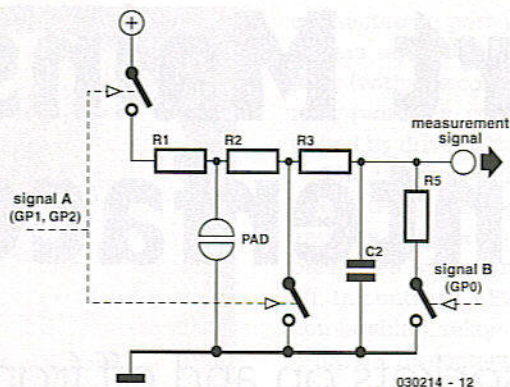

Figure 1. Principle of operation.

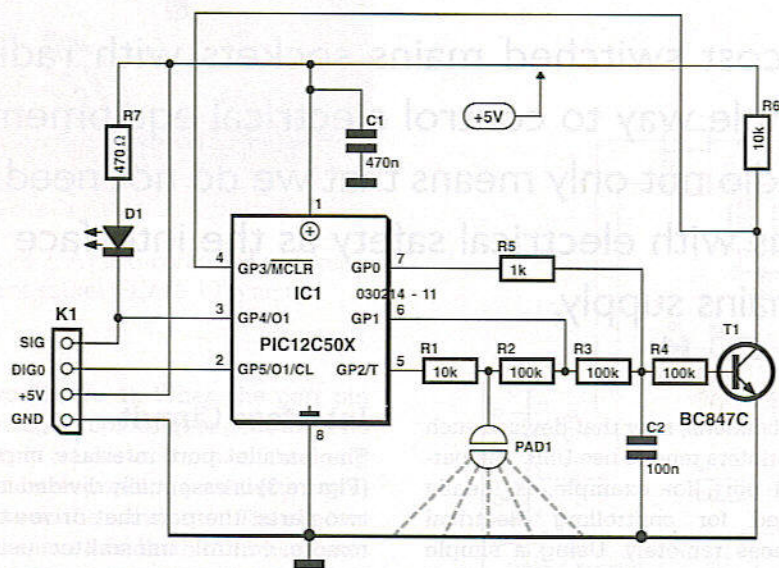

Figure 2. Circuit diagram of the Touch-controlled Switch.

where higher sensitivity is required, the surface area may be increased.

The circuit is capable of adaptive operation. This means that the trigger point is shifted (within limits) to compensate for effects like dirt on the touch pad. Only relatively fast capacitive changes are recognised as valid actions. Also, the fact that the measurement is completely done in software can be exploited by making clever use of the energy reduc-

tion features offered by a PIC. Because a measurement takes only 50 ms and it is sufficient to do measurement every 500 ms, the controller could be 'asleep' most of the time. The upshot is that the average current consumption of the circuit can

be reduced to 0.1-0.2 mA without problems.

The circuit is made relatively immune to constant external RF signals by the software varying the speed of signal 'A' to some extent.

(030214-1)

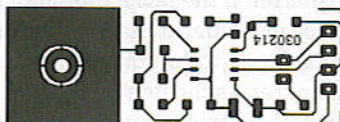
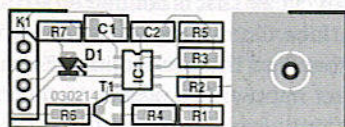
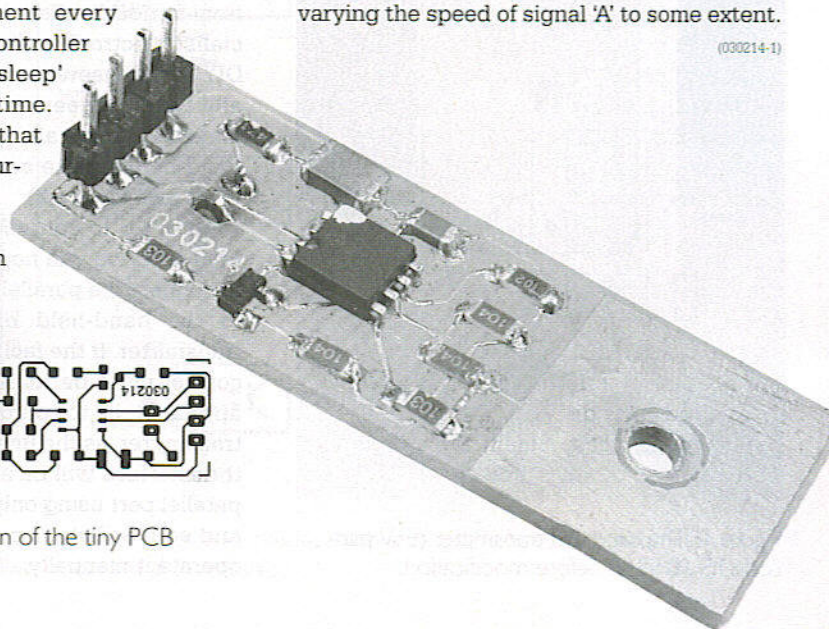

Figure 3. Copper track layout and component mounting plan of the tiny PCB designed for the circuit.



# Parallel Port Mains Switching Interface

switch radio-controlled mains sockets on and off from a PC

by K. Heiden

The wide availability of low-cost switched mains sockets with radio remote control provides a simple way to control electrical equipment, lights, etc. using a PC. Using radio not only means that we do not need a cable, but also avoids problems with electrical safety as the interface is electrically isolated from the mains supply.

As USB interfaces become more widespread on PCs the serial and parallel ports are becoming less and less important. Most computers, however, still offer the 'legacy' ports which are available for new

applications, now that devices such as printers tend to use USB. The parallel port, for example, is ideally suited for controlling electrical devices remotely. Using a simple switch interface it is possible to turn household appliances on and off under PC control.

So as not to add to the cable spaghetti already associated with the PC, the remote control described here uses a modified radio-controlled mains switch. These are available from various outlets including specialist electronics shops as well as DIY and housewares shops. Generally two or three switched sockets are sold as a set along with a single hand-held remote control (see **Figure 1** and **Figure 2**).

In order to control the switches from a PC we will need an interface to connect the parallel port of the PC to the hand-held remote control transmitter. If the facility for manual control must be retained, the best approach is to purchase another transmitter, as the unit connected to the interface will be attached to the parallel port using only a short cable and so it will not be convenient to operate it manually.

## Interface Circuit

The parallel port interface circuit (**Figure 3**) is essentially divided into two parts: the part that drives the remote control transmitter using optocouplers, and two optional extra switching stages built around IC1 and two relays. This switching circuit allows for the control of two additional devices, located near to the PC, directly from the interface. If this feature is not required, the switching stages can be left out, and signals D0, D1 and D3 (port pins 2, 3 and 5 of the 25-way sub-D plug) left unconnected.

Port signals D4 to D7 (pins 6, 7, 8 and 9 of the 25-way sub-D plug) are connected to the remote control transmitter via a quad optocoupler device (IC2, type ILQ74). **Figure 1** also shows the pinout of this device.

The circuit diagram only shows the part of the remote control transmitter circuit that is connected to the interface circuit, namely the push-buttons and the connections for the power supply. The pushbutton connections for the transmitter are brought out on four wires labelled A to D and connected to the output transistors of the optocouplers (see

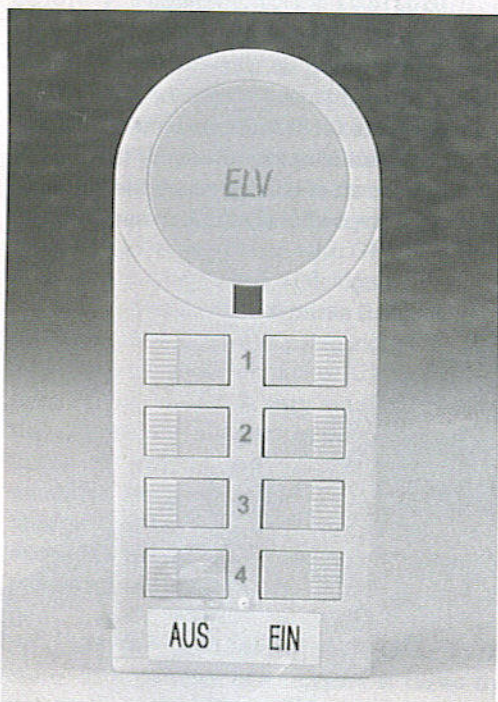

Figure 1. The handheld transmitter (ELV part code FS 10 S8-2) before modification.



Figure 2. A radio-controlled switched mains socket (ELV FS 10 system).

also **Figure 4**). When the port pin driving an optocoupler goes high, its output transistor conducts, bridging the corresponding pushbutton contacts on the transmitter. The effect is the same as if the button had been pressed (channel 2 on/off, channel 3 on/off and so on). We can arrange for the pin on the parallel port to be taken high using suitable software. The components between the parallel port and the optocoupler (the series resistor and the diode) serve to limit current flow and protect both the input LED of the optocoupler and the output transistors of the parallel port.

The interface circuit also includes a power supply for the remote control transmitter. The transmitter batteries (two button cells in the type we used) should be removed and connections made to the points marked '+' and '-' in the circuit diagram. A voltage of 3 V for the transmitter is derived from the 12 V supply of the interface using D2, R11, C8 and Zener diode D3. The interface circuit itself can be powered from a 12 V mains adaptor connected to K1 or by connecting to the PC's internal 12 V supply.

The optional switching stages

connected to port pins D0, D1 and D3 are equipped with one normal relay (with one coil) and one latching relay (with two coils). They are controlled by driver IC1 (type ULN2803).

The latching relay (RE1) is controlled using port signals D0 and D1 and has the feature that its state is preserved when power is switched off. In contrast, RE2 is an ordinary, non-latching, relay and is controlled using D3. Its contacts are closed only while current flows in the coil. Switching pulses can be generated using this relay with a duration under software control. Thus it is

suitable, for example, for driving an electrically-operated door latch from the PC, connecting the relay contacts in parallel with the button for opening the door.

You may be wondering why there are no protection diodes across the relay coils: this is because suitable diodes are already built into the ULN2803.

A 25-way male sub-D connector is required to connect the interface circuit to the parallel port. A cable with at least eight conductors is required for the connection, with the 25-way sub-D connector at one and suitable connector at the other. If it is desired to use a spare ordinary printer cable, a 36-way Centronics-style socket will be required.

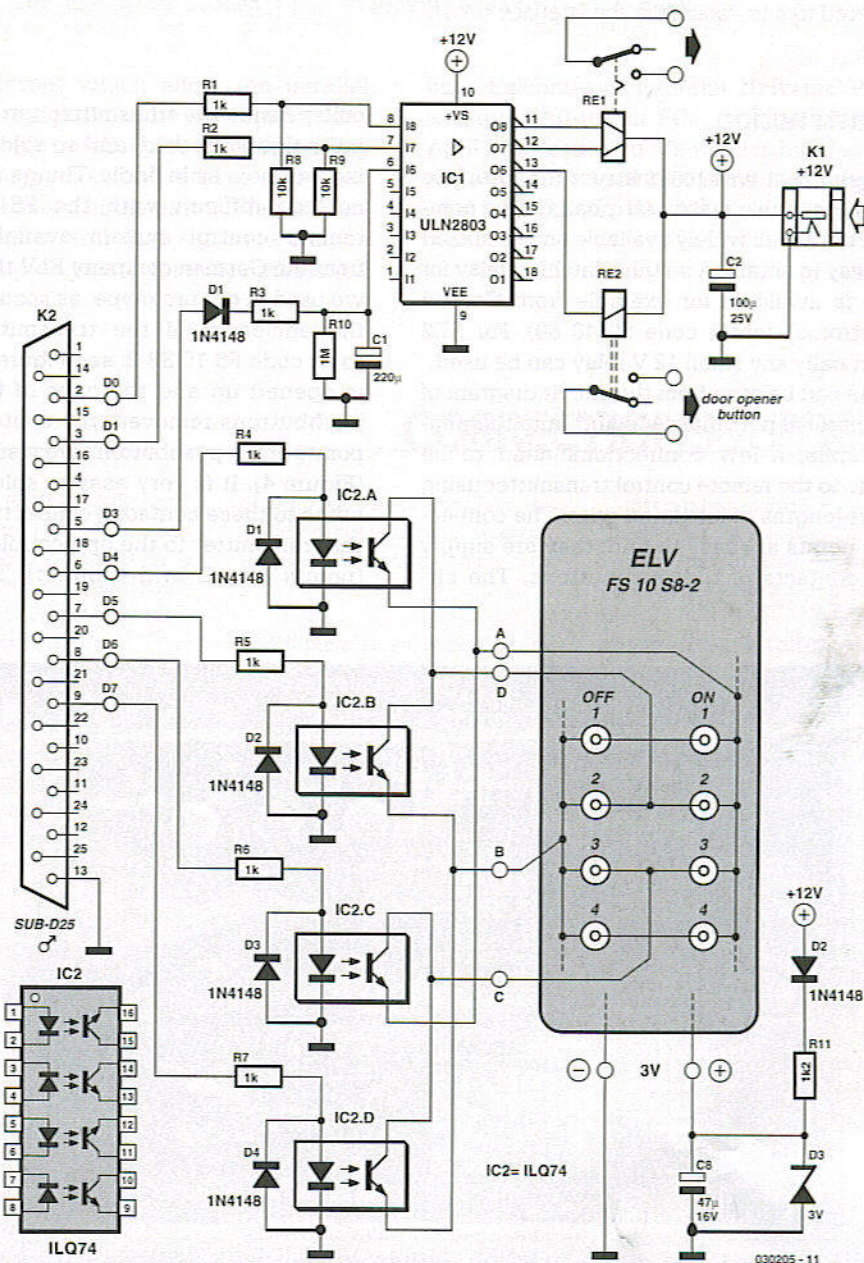

Figure 3. The circuit of the parallel port interface connects to the handheld transmitter via optocouplers. Two relays are also available.

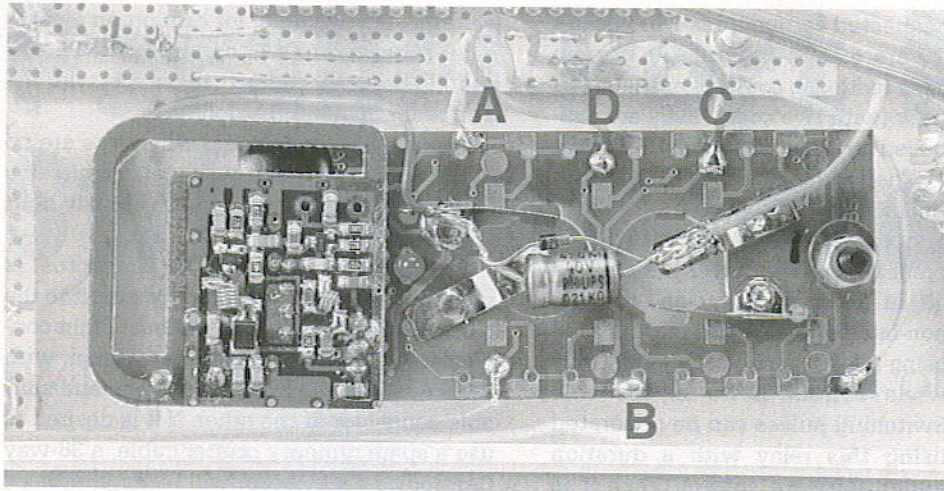

Figure 4. The printed circuit board (author's design) of the handheld transmitter with wires soldered to it to connect to the interface circuit.

## Construction

The simplest way to construct the interface circuit is to use matrix stripboard. The components are all widely available and so should be easy to obtain. A suitable latching relay for RE1 is available for example from Conrad Electronics (order code 50 40 60). For RE2 practically any small 12 V relay can be used.

As can be seen from the circuit diagram of the parallel port interface and from the photographs, a few connections need to be made to the remote control transmitter using short lengths of insulated wire. The connection points are easy to find: they are simply the contacts of the pushbuttons. The cir-

cuitry inside the transmitter can be quite tightly packed, and so soldering can be a little fiddly. Things are not too difficult with the FS 10 remote control system available from the German company ELV that we used in our prototype: as soon as the enclosure of the transmitter (part code FS 10 S8-2: see Figure 1) is opened up and the caps of the pushbuttons removed, the contact points of the pushbuttons are visible (Figure 4). It is very easy to solder wires to these contacts, connecting the transmitter to the optocouplers (points A to D in the circuit). The

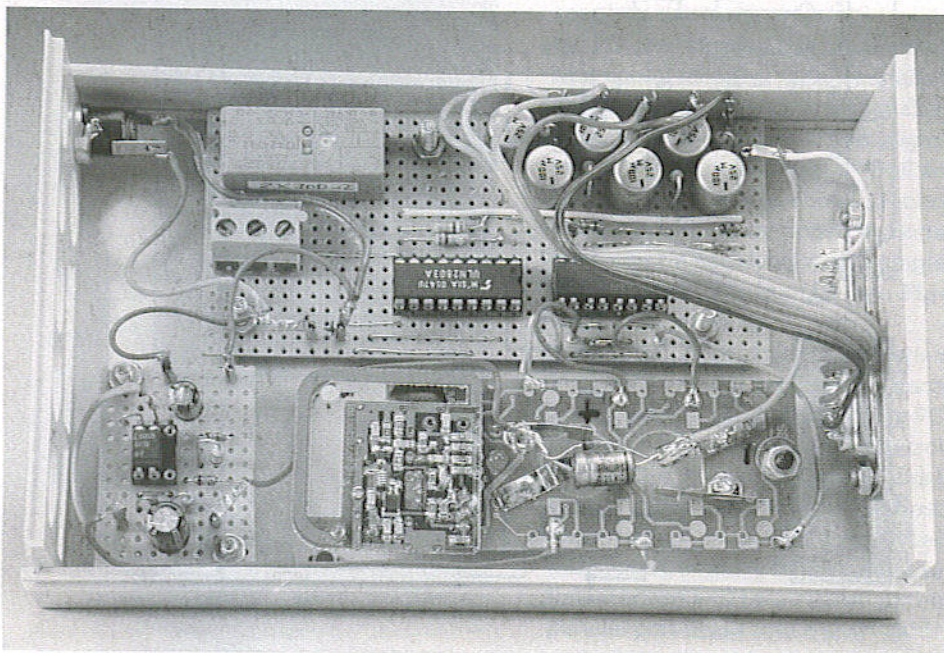

Figure 5. The switching interface built into a plastic enclosure.

pushbuttons can no longer be used.

The completed assembly can be protected by a plastic enclosure (Figure 5, which shows a slightly modified version of the interface).

## The Software

The control software is as straightforward as the interface circuit. All it has to do is set the individual bits of the parallel port high for a period of about one second, and then low again. We do this using a COM file, which is created in advance with the aid of a VB (Visual BASIC) script. First type in the program Mk\_COM.vbs shown in the text box using any suitable text editor (such as WordPad or Notepad), and save it under this name in any directory on the hard disk. Now run the program by double-clicking on the filename: this will create the file SETLPT.COM in the same directory. The VB script can now be deleted.

The various switching actions can be carried out using the following commands:

- SETLPT 1:01 switches the latching relay on.
- SETLPT 1:02 switches the latching relay off.
- SETLPT 1:08 switches the non-latching relay (briefly) on.
- SETLPT 1:10 switches remotely-controlled mains socket 2 on.
- SETLPT 1:20 switches remotely-controlled mains socket 2 off.
- SETLPT 1:40 switches remotely-controlled mains socket 3 on.
- SETLPT 1:80 switches remotely-controlled mains socket 3 off.

The space after 'SETLPT' must not be omitted. The digit '1' after 'SETLPT' and the space refer to parallel port LPT1. The characters after the colon are hexadecimal digits which define the value which will be sent to the parallel port: two digits must always be specified. The assembler routine sets the parallel port to the value given after the colon for about 1 s, and then sets it back to zero again so that only a brief positive pulse will appear on the data line. If you have a second parallel port ('LPT2') on your computer which you wish to use with the interface, then the command



should read 'SETLPT 2:XX'. A note for PC experts: the I/O base address used for LPT1 is 0378 hex, that for LPT2 is 0278 hex.

You can create a shortcut to the file SETLPT.COM with parameter '1:08' on the desktop, and call it 'Open Door'. Then, when someone rings the doorbell while you are busy at the computer, just double click on the icon and the door opener will be activated. To prevent the DOS window appearing, right-click on the icon and select 'Properties'. Then, under 'Shortcut' select 'Run minimised' and 'Close window on exit'.

### Conclusion

The author has been using the circuit for many months without any problems, mainly in conjunction with an SMS remote control circuit previously published in *Elektor Electronics*.

If you prefer to control the interfaces using Windows, there are small programs available on the

The following file, 'Mk\_COM.vbs', can be typed in and run to create the assembler file 'SETLPT.COM' automatically. Alternatively, the file 'SETLPT.COM' can be downloaded directly from the *Elektor Electronics* website at [www.elektor-electronics.co.uk](http://www.elektor-electronics.co.uk) (select this issue).

```
d = "186,120,003,138,030,130,000,128,251,049,"
d = d & "116,007,128,251,050,117,030,254,206,160,"
d = d & "132,000,044,048,177,004,210,224,138,038,"
d = d & "133,000,128,236,048,008,224,177,001,056,"
d = d & "200,116,009,208,225,117,248,184,001,076,"
d = d & "205,033,238,187,000,004,226,254,075,117,"
d = d & "251,184,000,076,238,205,033"
t = split(d, ",")
Set fso = CreateObject("Scripting.FileSystemObject")
Set File = fso.CreateTextFile("SETLPT.COM", true)
for n = 0 to ubound(t) : File.write chr(t(n)) : next
```

Internet which allow the parallel port signals to be set high or low. Simple parallel port interfaces using Windows software have also been published in the past in *Elektor Electronics*, and that software can be adapted for the interface presented

here. Examples include the 'Universal Parallel Input/Output for PCs' on page 20 of the April 2000 issue and 'Centronics Interface' on page 28 of the April 1996 issue. The book 'PC Interfaces under Windows' is also recommended.

(030205-1)

## CORRECTIONS&UPDATES

### Digital Logic Compared

December 2003, p. 98, 030317-1  
The drawing in Figure 2b is incorrect. The input should be connected directly to the FET gates. The anode of the lower diode should go to ground and the cathode of the upper diodes to +Vcc, protecting the inverter input against harmful over- and undervoltages.

### PICProg 2003 FAQ

This project from our September 2003 issue has been immensely successful and the following frequently asked questions (FAQs) have been gathered from readers' correspondence regarding this design. The answers are provided jointly by the author and our in-house design staff.

1. I'm having problems with COMDLG32.OCX. An error report pops up telling me OCX is out of date.

In most cases, this problem may be solved simply by copying all ocx (\*.ocx) files to the Windows\System or Windows\System32 directory.

2. READ on a PIC16F84 fails. Nothing happens. I get error report TRANSMISSION FAILED, or a READ window opens and nothing happens. The operation is occasionally successful.

You're looking at bad communication between PC and programmer, usually with laptops and notebooks. Replace T3 with a BC547, omit R20 and fit a 10k resistor between pin 7 of K2 and the base of T3. A future version of the software will contain communication error signalling and reporting.

3. The PIC16F874A cannot be programmed; however no problems are encountered with the standard version (no A suffix).

The A versions employ a different algorithm. Support will be incorporated in an update.

4. Can you offer support for the PIC16C54, -C55 and -C57?

Sorry, we can't. These processors have been omitted right from the start because they are more expensive than comparable Flash types. We may investigate the possibilities

of using equivalent types from the 16C55x series with serial programming capabilities. This is quite complicated however.

5. Will there be an update for the 16xxx series?

These new PICs are also eligible for support through an update. However we need to get samples first.

6. Erasing a PIC16F628A and reprogramming it produces an error at address 0000. The same with the PIC16F73.

The problem is under investigation, it may be the same as with the 16F874A. A 16F73 has only just arrived.

7. Where can I buy or download the HEX or BIN file to program my own PIC in position IC6?

As already explained in an earlier Correction/Update (November 2003), the code cannot be made available because the author receives royalty payments for every copy sold of the ready-programmed PIC.

8. Where's the list of PIC devices

that can be handled?

The list can be retrieved from the Windows program itself but for your convenience, here's a printed version:

12C508, 12C508A, 12C509,  
12C509A, 12CR509A, 12CE518,  
12CE519, 12C671, 12C672,  
12CE673, 12CE674, 12F629,  
12F675, 16C505, 16C554, 16C556,  
16C558, 16C61, 16C62, 16C62A,  
16C62B, 16C620, 16C620A, 16C621,  
16C621A, 16C622, 16C622A,  
16CE623, 16CE624, 16CE625,  
16F627, 16LF627, 16F627A, 16F628,  
16LF628, 16F628A, 16C63, 16C63A,  
16F630, 16C64, 16C64A, 16C642,  
16C65, 16C65A, 16C65B, 16C66,  
16C662, 16C67, 16F676, 16C71,  
16C710, 16C711, 16C712, 16C715,  
16C716, 16C72, 16F72, 16C72A,  
16C73, 16F73, 16C73A, 16C73B,  
16C74, 16F74, 16C74A, 16C76,  
16F76, 16C77, 16F77, 16CR83,  
16F83, 16C84, 16CR84, 16F84,  
16F84A, 16F87, 16F88, 16F818,  
16F819, 16F870, 16F871, 16F872,  
16F873, 16F873A, 16F874,  
16F874A, 16F876, 16F876A,  
16F877, 16F877A.

# iAccess

an intelligent access control system

Design by I. Joostens

Surveys show that people are feeling increasingly less safe. Consequently, protecting property and buildings receives more and more attention these days. One of the aspects of such protection is access control. The system described here goes further than most such systems. Besides granting persons selective access to specific areas, iAccess allows you to check who was granted access to which area and when.

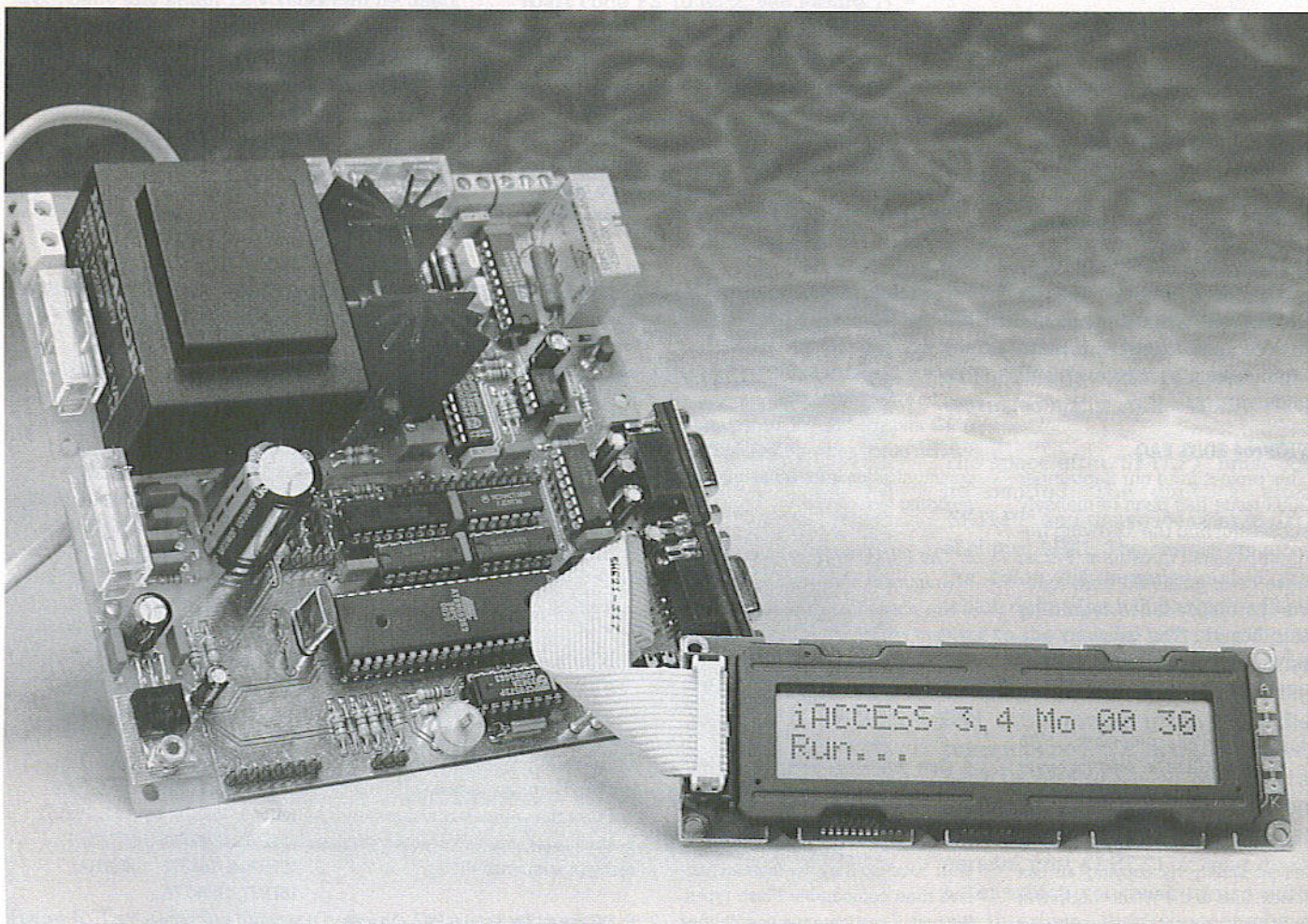

## Features at a glance

- up to 125 keys can be programmed
- independently controls two entrances using two readers
- access privileges can be individually configured for each key
- protected against scanning
- system configuration using an LCD menu or an RS232 link to a PC
- outputs can be configured as monostable (door opener) or bistable (relay)
- door openers can be powered by AC or DC voltages
- optional indicator LEDs
- programming port for easy firmware updating
- activities can be logged via an RS232 link
- backup power supply using a lead-acid battery
- high reliability ensured by a watchdog timer

Nowadays, access control systems are available from quite a few manufacturers. These are usually either quite elaborate systems designed for thousands of users and offering a large number of features, or very limited models that are more suitable for private use.

Most commercially available systems use electronic keys, such as magnetic cards, badges, iButtons, or transponders. There are also models that use PIN codes and/or biometric features.

The circuit described in this article combines the versatility and features of the large systems with the simplicity and ease of use of the small, stand-alone types. Here iButtons are used as electronic keys. Relative to other key systems, iButtons offer quite a few advantages, such as ready availability, a high level of robustness, and the fact that the user interface (reader) consists of only a simple set of contacts. **Figure 1** shows a photo of an iButton with its associated read probe.

Two entrances are independently monitored. The circuit includes a driver for a door opener as well as a relay output. The latter is suitable for enabling or disabling an alarm system, among other things. An optional link to a computer can be used to configure the system and record events in a log file.

## Concept and block diagram

The overall structure of the access control system is shown in **Figure 2**. As can be clearly seen, the key element is a microcontroller. It looks after reading the iButtons, handles

communications via the RS232 interface and controls the peripheral components.

The microcontroller used here has 2 KB of EEPROM, which stores the physical key numbers (as engraved on the iButtons) and associated access privileges, as well as the system configuration parameters.

A special programming interface allows the microcontroller software to be easily updated. As the program uses a fairly large number of interrupts, it was not possible to have the microcontroller maintain the time of day using software. Consequently, a real-time-clock IC is used for this purpose.

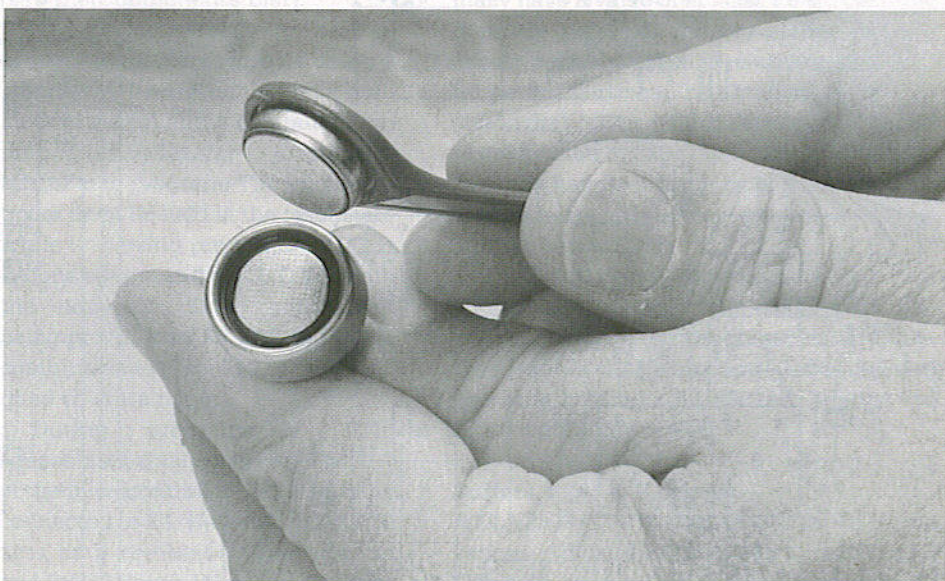
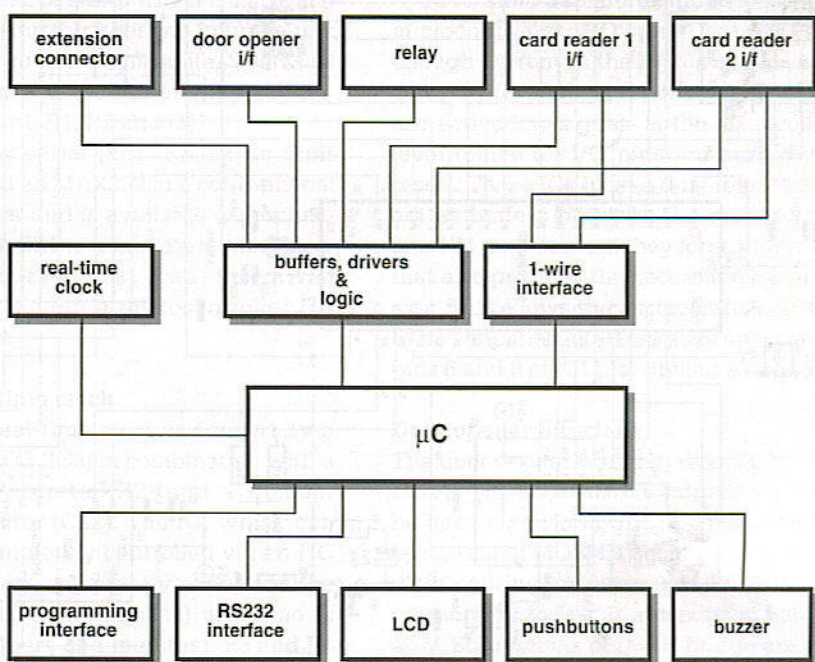

Figure 1. A DS9092 iButton with associated read probe.



020163-12

Figure 2. Block diagram of the access control system.

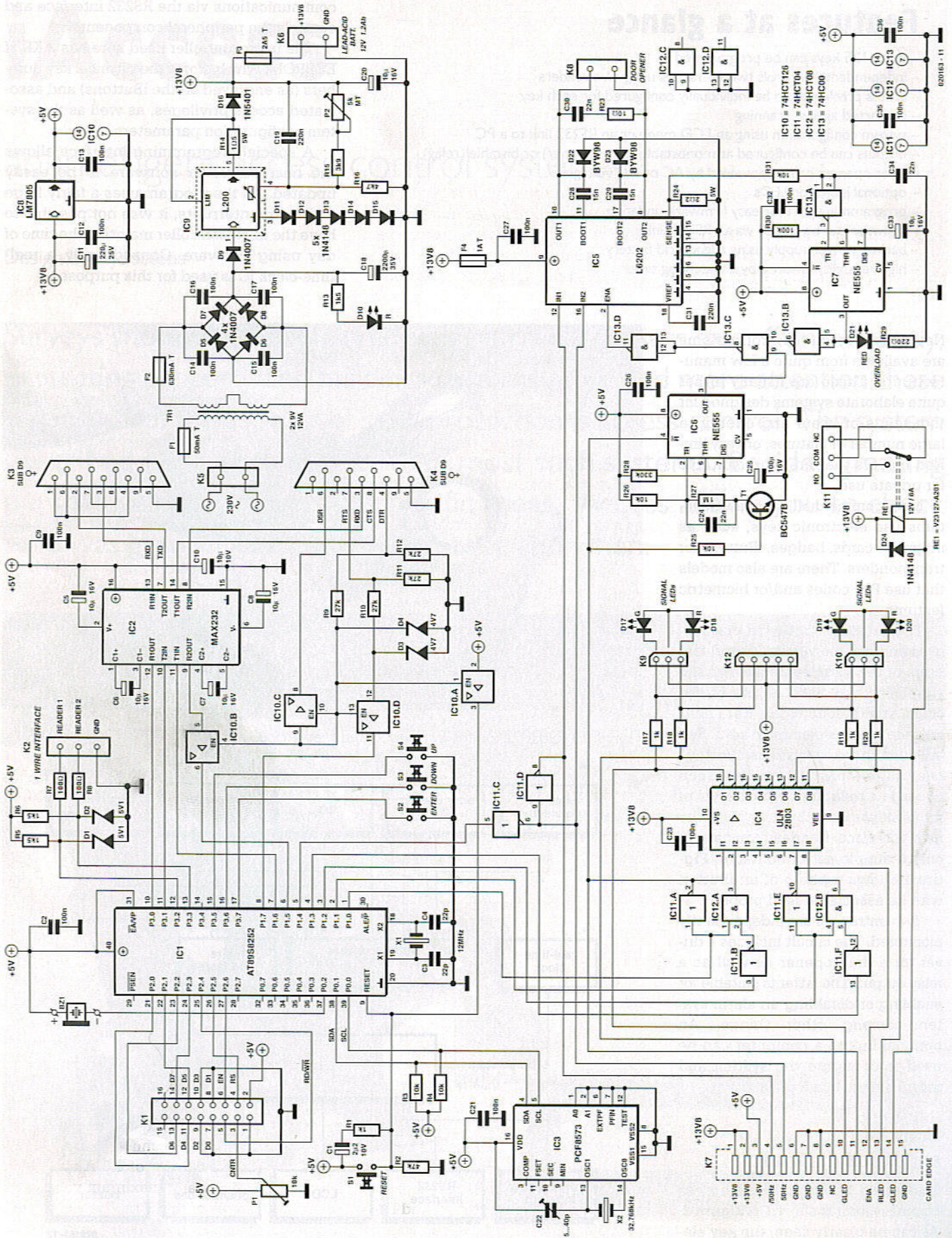

Figure 3. Schematic diagram of the complete system.

The user interface is formed around an LCD module, four push-buttons (including the reset button) and a miniature buzzer. To reduce the number of I/O pins used, the LCD is driven in 4-bit mode.

The iButtons are read using an intentionally simple 1-wire interface. As the length of the 1-wire bus will be relatively short in most cases, and only one 1-wire device will be connected to the bus each time, the bus does not have to meet particularly severe requirements. Key readers can be fitted with status indicators using red and green LEDs.

The system can drive most types of door openers that are suitable for use with a 12-V supply voltage. A circuit specially developed for this purpose allows the door opener to be driven using an AC or DC voltage as desired. To prevent possible damage to the access control system or the door opener in case of improper use or fault conditions, several supplementary protective measures have been incorporated.

As already mentioned, besides the door opener driver circuit there is also a relay output that can be used for additional switching functions. Finally, an expansion connector has been added for users who wish to experiment with the circuit.

Power for the entire circuit is provided by a lead-acid storage battery that is continuously recharged by a mains power supply. This provides two significant benefits. First, in case of a power outage the system will continue to operate from the battery for an extended length of time, so access to an area or building remains assured. Besides this, using a storage battery allows the mains power supply to be relatively modest in size, since the short current pulses needed to operate the door opener are provided by the battery instead of the mains supply.

## Schematic diagram

The full schematic diagram of the system is shown in **Figure 3**. The functional blocks shown in **Figure 2** can be recognised here without too much effort. The most important elements are described in more detail below.

## Microcontroller, user interface, RS232 interface and programming port

Microcontroller IC1, an AT89S8252, is used here in a quite conventional manner. No external program memory is used; all of the firmware is located in the microcontroller's 8-KB Flash memory. A fully programmed version of the microcontroller can be purchased from Readers Services, but the source code and executable software are also available from the *Elektor Electronics* website or on a pair of diskettes (see the Components List).

The microcontroller can be programmed via connector K4 using a standard 1:1 serial cable (not a null-modem cable) and a computer running the *Elektor Electronics* MicroFlash program. The microcontroller must be held in the reset state while it is being programmed. This is done using pin 4 of K4 (DTR), with the necessary level adjustment being provided by R9, R12 and D4, in combination with IC10, a 74HC126 quad tri-state buffer.

During programming, IC10 causes the signals on pins P1.5–P1.7 of the microcontroller (SPI bus) to be connected to K4. Here IC2 (MAX232) acts as a combined level adapter and RS232 driver. When the DTR line on pin 4 of K4 again goes low, the outputs of IC10 go into a high-impedance state, which isolates the programming interface from the rest of the circuit. In this state, S1 acts as a normal reset button (in combination with R1, R2 and C1).

The serial port (RS232) is built around an MAX232 in a conventional manner and is available on connector K3. BZ1 is a miniature piezoelectric buzzer that can be driven directly from a microcontroller I/O output.

## Real-time clock

The real-time clock is formed by a PCF8573 (IC3) in combination with a watch crystal (X2) and a trimmer capacitor (C22). The IC, which can be completely controlled via an I<sub>2</sub>C interface, accurately maintains the date (day and month) and time of day (hours and minutes). R3 and R4 are included because the microcontroller P0 port does not have internal pull-up resistors.

## 1-wire interface

The 1-wire interface is connected to microcontroller interrupt pins INTO (P3.2) and INT1 (P3.3) via several resistors and Zener diodes. When an iButton is held against a key reader, the associated I/O pin of the microcontroller is briefly pulled to ground. This generates an interrupt, which triggers an interrupt routine that ultimately reads the data from the iButton for further processing by the main program.

As the internal pull-up resistors in the microcontroller have fairly high resistances, R5 and R5 are included to provide additional current for the 1-wire bus. According to the 1-wire protocol specification, R5 and R6 normally have a value of at least 1.5 k $\Omega$ , but if the distance between the key reader and the access control system is relatively long, better performance can be obtained by using a somewhat lower value. From experimental tests, a value of 820  $\Omega$  will allow the system to easily handle a distance of more than 100 metres between the access control system and the key reader.

R7, R8, D1 and D2 protect the I/O pins against high voltages from electrostatic discharge or attempted sabotage. For instance, they enable the microcontroller to survive someone holding a 9-V battery against the contacts of a key reader.

## Buffers, logic and drivers

A ULN2803 (IC4) is used as a driver IC for the various indicator LEDs and the output relay. This IC contains eight open-collector drivers, each of which can switch a maximum current of around 500 mA.

IC11 and IC12 are included because the microcontroller I/O pins cannot supply enough current in the high state to properly drive a ULN2803, and because we prefer to use active-low signals at the microcontroller level (since all I/O pins are high during a reset). These ICs have a dual role. First, they act as buffers between the microcontroller and IC4, and second, they form a logic circuit that also provides the necessary signal inversion. This allows the microcontroller software to be simplified. 50-Hz signals are present on pins 6 and 8 of IC11 for driving a door opener.

## Door opener interface

The door opener is driven directly by IC5, an L6202. This IC, which is actually intended to be used as a motor driver, contains a full H-bridge using MOSFET technology. It can handle a continuous current of 1.5 A and peak currents up to 5 A at a maximum voltage of 48 V. Both halves of the H bridge are driven by the 50-Hz signals from the microcontroller. Whether the door opener actually receives any current depends on the signal at the

Enable input of the IC. This signal is set high by the microcontroller after a valid key has been presented. However, this does not happen just like that; there is also protective circuitry in the signal path.

The first protective circuit is built around IC6, which is a 555 wired as a monostable timer with a period of approximately 30 seconds. When the signal on pin 2 of IC11 goes high, T1 is switched on via R25. This causes the trigger input of IC6 (pin 2) to be briefly pulled to ground until C24 has been charged. The rising edge on pin 2 of IC11 does not affect the Reset input of IC6, which is active low, so the timeout starts running at this point. If the signal on pin 2 of IC11 returns to the low level during the 30-second interval, the falling edge on pin 4 of IC6 will reset IC6.

The direct effect of this is that the output signal on pin 3 exactly follows the Enable signal as long as it does not stay high longer than 30 seconds; otherwise IC6 will indepen-

dently disable the output signal. This prevents the door opener from being enabled for an extended length of time, which would be detrimental to both the coil of the door opener and the lead-acid battery.

A second protective circuit prevents IC5 from being overloaded and acts as a sort of current limiter. The current flowing through the door opener and IC5 reaches ground via sense resistor R24. The voltage across R24 is fed via R31/C34 (for noise suppression) to NAND gate IC13a, which is wired as an inverter. As soon as the voltage on pins 1 and 2 of IC13 reaches half the supply voltage level, IC13 will see this as a 'high' logic level and pin 3 will go low. This occurs with a current of approximately 1.14 A ( $2.5\text{ V} \div 2.2\ \Omega$ ). This will cause timer IC7 to be trig-

gered via pin 2 and start a timeout of around 1 second. Pin 3 of IC7 will go high, and overload indicator D21 will be illuminated. The Enable signal on pin 2 of IC5 will be pulled low via IC13b-d, interrupting the current. After 1 second, IC7 will reset itself, and if the overload condition has been corrected the circuit will again be operational. If the overload is still present, IC7 will immediately be retriggered after resetting itself. The net result is a series of short current pulses at a one-second rate, which will not harm IC5.

### Power supply

The power supply consists of a charging circuit built around voltage regulator IC9 and a small lead-acid storage battery rated at 12 V/1.2 A. To keep the ripple component of bat-

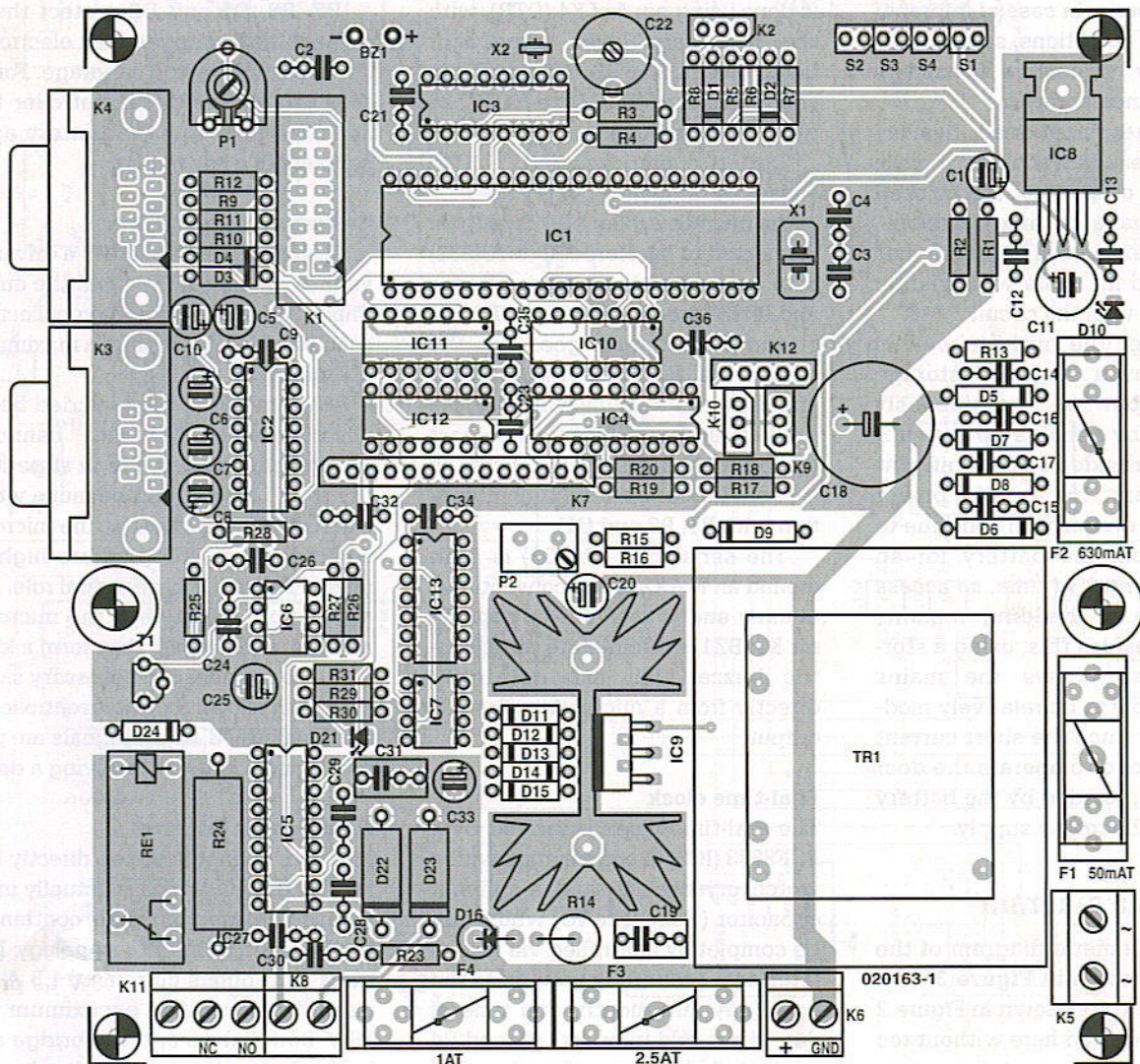

Figure 4. The circuit is assembled on a double-sided printed circuit board. The LCD is connected to K1.

tery charging voltage as small as possible, smoothing capacitor C18 has been generously dimensioned. D16 prevents current from flowing in the reverse direction during a mains outage. Diodes D11–D15 are included to provide temperature

compensation. If the temperature increases, the voltage across the diodes will decrease, which will cause the charge voltage on the battery to increase. The charge voltage can be adjusted within certain limits using P2.

## Components list

### Resistors:

R1, R17–R20 = 1k $\Omega$   
 R2 = 47k $\Omega$   
 R3, R4, R25, R26, R31 = 10k $\Omega$   
 R5, R6 = 1k $\Omega$   
 R7, R8 = 100 $\Omega$   
 R9–R12 = 27k $\Omega$   
 R13 = 1k $\Omega$   
 R14 = 1 $\Omega$  5W  
 R15 = 3k $\Omega$  9  
 R16 = 4k $\Omega$  7  
 R21, R22 = not used  
 R23 = 10 $\Omega$   
 R24 = 2 $\Omega$  2 5W  
 R27 = 1M $\Omega$   
 R28 = 330k $\Omega$   
 R29 = 220 $\Omega$   
 R30 = 100k $\Omega$   
 P1 = 10k $\Omega$  preset  
 P2 = 5 k $\Omega$  multiturn (vertical mounting)

### Capacitors:

C1 = 2 $\mu$ F/10V radial  
 C2, C9, C12–  
 C17, C20, C21, C23, C26, C27, C32, C33, C35, C36 = 100nF  
 C3, C4 = 22pF  
 C5–C8, C10 = 10 $\mu$ F 16V radial  
 C11 = 220 $\mu$ F 25V radial  
 C18 = 2200  $\mu$ F 35V radial  
 C19, C31 = 220nF  
 C22 = 5–40pF  
 C24, C30, C34 = 22nF  
 C25 = 100 $\mu$ F 16V radial  
 C28, C29 = 15nF

### Semiconductors:

D1, D2 = 5V1 500mW  
 D3, D4 = 4V7 500mW  
 D5–D9 = 1N4007  
 D10, D18, D20, D21 = LED, red, low current  
 D11–D15, D24 = 1N4148  
 D16 = 1N5401  
 D17, D19 = LED, green, low current  
 D22, D23 = BYW98  
 IC1 = AT89S8252–12PC, programmed, order code **020163-41**  
 IC2 = MAX232  
 IC3 = PCF8573 P  
 IC4 = 2803 or TD62083AP  
 IC5 = L6202  
 IC6, IC7 = NE555

IC8 = LM7805 TO220  
 IC9 = L200  
 IC10 = 74HCT126  
 IC11 = 74HCT04  
 IC12 = 74HCT08  
 IC13 = 1x 74HC00  
 T1 = BC547B

### Miscellaneous:

BZ1 = DC (active) buzzer, 5 or 6V  
 F1 = fuse, 50mA T (slow) with PCB mount holder  
 F2 = fuse, 630mA T (slow) with PCB mount holder  
 F3 = fuse, 2A5T (slow) with PCB mount holder  
 F4 = fuse, 1A T (slow) with PCB mount holder  
 K1 = 16-way boxheader  
 K2, K9, K10 = 3-way SIL-header  
 K3, K4 = 9-way sub-D socket (female), PCB mount, angled pins  
 K5 = 2-way PCB terminal block, lead pitch 7.5mm  
 K6, K8 = 2-way PCB terminal block, lead pitch 5mm  
 K7 = 14-way SIL pinheader  
 K11 = 3-way PCB terminal block, lead pitch 5mm  
 RE1 = V23057-B0002-A201 (12-V relay, 1 changeover contact)  
 S1–S4 = pushbutton, 1 make contact  
 TR1 = mains transformer, 2 x 9V/12VA (e.g., Monacor/Monarch type VTRI2209)  
 X1 = 12MHz quartz crystal  
 X2 = 32.768kHz quartz crystal  
 Heatsink for IC9: Fisher type SKI29, 38.1mm high, 6.5 K/W  
 Sealed lead-acid battery 12V/1.2 Ah  
 LCD module, 2 x 20 characters, HD44780 compatible, e.g., Hitachi LM032 or JHD JM202A  
 PCB, order code **020163-1** (see Readers Services page)  
 Disk set (2 pcs), contains source code files and control software, order code **020163-11** or **Free Download**

### Also:

Any no. of iButtons type DS1990A  
 Optional: iButton holders type DS9093A  
 Reader probe type DS9092 (optionally -L or -T)

## Construction, alignment and commissioning

The circuit is built on a double-sided printed circuit board with plated-through holes, which is illustrated in **Figure 4**. Despite the complexity of the schematic diagram, assembling the board should not present any significant problems. Use IC sockets for all ICs and check that the values and polarities of the components are correct before soldering them in place, since it can be difficult to unsolder components from a circuit board with plated-through holes.

After assembling the board, do not immediately fit the ICs in their sockets, and leave the LCD disconnected for the time being.

Turn P2 fully to the left and connect K5 to the mains. Using P2, adjust the voltage on K6 (the connector for the lead-acid battery) to exactly 13.8 V. Then check the 5-V supply voltage at pins 1 and 2 of K1 and at each of the IC sockets, except for IC4 and IC5 (which receive 13.8 V).

Switch off the mains voltage and rotate C22 so the plates of the capacitor are half engaged. Set P1 to its mid-range position.

Now insert all ICs into their sockets and connect the LCD to K1 using a length of 16-way flat cable. Switch the mains voltage on again. At this stage, it is quite normal for the circuit to not do anything, since the firmware is missing.

Using a standard 1:1 serial cable, connect the programming port (K4) to a free serial port on a computer. Unzip the Zip file containing the firmware and put all the files in a folder on the hard disk. Start the program MicroFlash.exe, which is located in the folder with the firmware, and select the proper COM port. Click on 'Flash hex' and select file 'iacc-v35.hex' or equivalent (depending on the version number). The microcontroller will now be programmed. Depending on the speed of your computer, this may take a few minutes. As soon as the programming is finished, the microcontroller will be reset and the main program will start to execute in Run mode. Normally, buzzer BZ1 should emit a short beep at this time.

Using P1, adjust the contrast of the LCD. If everything has gone well, the following text will now appear on the LCD: 'iACCESS 3.5 Mo 00:00', 'Run...'

Allow the entire circuit to warm up for 15 minutes, and then use P2 to again adjust the voltage on K6 to 13.8 V as precisely as you can.

If you have a frequency meter, you can connect it between ground and pin 11 of IC3. You can then adjust C22 so the signal has a period of 7.8125 ms (128 Hz). If you don't have

▶ Program new key	Apply key to reader Select key nr _001 Key 001 stored	Replace key 001? _N Key exists (001) Key 001 stored
▶ Edit key	▶ Access rights out1	Access out1? _Y Access on Mon? _Y ... Access on Sun? _Y
	▶ Access times out1	from_00:00 to 00:00
	▶ Access rights out2	Access out2? _Y Access on Mon? _Y ... Access on Sun? _Y
	▶ Access times out2	from_00:00 to 00:00
	▶ Back to mainmenu	
▶ Erase key	Select key nr _001 Erase key 001? _N Key 001 erased	Key 001 is empty
▶ Set clock	Time_Mo 01/01 00:00	
▶ Output 1 properties	Output type _Mono Output delay _05s	
▶ Output 2 properties	Output type _Mono Output delay _05s	
▶ Output current	Set _AC current	
▶ Return to runmode		

Table 1. Overview of the menu structure.

a frequency meter, you can adjust C22 'by feel', depending on whether the clock runs fast or slow. Even without any adjustment, the clock is quite accurate.

After fitting the circuit board into a suitable enclosure, you should attach an identification label, as illustrated in **Figure 3**. As this is a mains-powered device, this is obligatory in connection with electrical safety.

## Basic settings

Provisionally connect four pushbutton switches to the S1–S4 positions on the circuit board. These buttons have the following functions: S1 = Reset, S2 = Enter, S3 = Down, S4 = Up.

Also provisionally connect an iButton probe to pins 1 and 3 of K2, with the centre contact of the probe attached to pin 1 and the outer contact connected to pin 3.

Press and hold the Up button. Briefly press the Reset button and wait approximately two seconds, then release the Up button. The system will enter the configuration mode and display a menu on the LCD. You can now use the Up and Down buttons to page through the various menu options. Do so until the option 'Output 1 properties' appears, and then press Enter. Then select 'Output type \_Mono' (you can use the Up and Down buttons to select one of two options: ' \_Mono' or ' \_Bi'). Press Enter and select a time, such as 'Output delay \_05 s'. Press Up or Down until

a time of 5 seconds is set; then press Enter. You will be returned to the main menu. Now select the option 'Output 2 properties', and under this option select 'Output type \_Bi' as the output type. Pressing Enter will again return you to the main menu. The door opener interface has thus been configured as a monostable interface with a period of 5 seconds, and the relay output has been configured as bistable.

Select the 'Output current:' option in the main menu and press Enter. Then use Up and Down to select 'Set \_AC current' and press Enter.

There is little point in setting the time before the board has been fully fitted in its enclosure and the lead-acid battery has been connected. Select 'Program new key' and press Enter. The message 'Apply key to reader' will appear on the LCD. Hold an iButton against the iButton probe. Once the key has been correctly read, you will hear a short beep, and the physical key number will be shown for 2 seconds on the LCD. After this, 'Select key nr. \_001' will appear. After you press Enter, the key will be stored under number 1. If you wish, you can use Up and Down to select a different key number in

the range 1–125 before pressing Enter. Key numbers already in use are marked by a # sign (e.g. \_065#).

Finally, select 'Return to runmode' in the main menu and press Enter. The system will execute a reset and return to the run mode. Now disconnect the middle lead of the iButton probe and connect it to pin 2 of K2. After this, each time the iButton that has just been programmed into the system is held against the reader probe, relay RE1 should be actuated. You can also test the door opener interface by again connecting the iButton probe to pins 1 and 3 of K2. Connect a load to K8 that can handle a 12-V AC voltage. If you use a 'heavy' load (> 300 mA), you must connect the lead-acid battery to K6 and allow it to charge if necessary. Each time the iButton is held against the reader probe, power will be applied to the load for 5 seconds.

## Overview of the menu structure

The menu structure is quite simple and intuitive. If you use **Table 1** as a reference, you should not have any significant problems. Nevertheless, a few remarks are in order with regard to keys and access privileges (which are called 'access rights' in the menus). A particular iButton can only be stored once in the memory. If you try to program the same iButton into the system more than once, an error message will appear.

Access privileges are assigned per key at three levels:

### – Level 1:

#### door opener or relay output

For each key and each door opener or relay output, you can specify whether the key is allowed to activate the door opener or the relay.

### – Level 2:

#### restriction to certain days of the week

For each key and each door opener or relay output, you can specify which days of the week the key is allowed to activate the door opener or relay.

### – Level 3:

#### restriction to certain times

An access period can be assigned



## Connection to a computer

Besides manual operation using the LCD and push-buttons, a computer can also be used to configure all of the system settings. If a large number of keys must be programmed into the system, this method is considerably faster and more convenient than the manual method. This is all made possible by the Windows program 'iAccess remote console', which is also available on the diskettes listed in the Components List.

Using a standard I:1 serial cable, connect K3 to a free serial port on the computer and then start the program. The first time you use the program, you must check the settings (9600 baud, 8N1) and modify them as necessary.

In the 'iAccess console' menu, select 'Establish link to remote system'. You now have to enter a password (which you can choose yourself the first time you use the program). Click on Continue, and the message 'Link established' will appear after a few seconds. 'RS232 control active' and 'Link established...' will be shown on the LCD. The system is in now in configuration mode.

Now you can use various menus to modify all the configuration settings of the access control system and program or edit keys. It is also possible to generate a backup and/or reset all of the programmed keys, along with their associated access privileges. This function is extremely handy if you wish to update the firmware of a configured system using MicroFlash, since doing so will erase the EEPROM in the microcontroller. When you are finished, select 'Disconnect from remote system' under the 'iAccess console' menu, and the system will return to the run mode.

Each time a key is read, information is displayed on the bottom line of the LCD. This information consists of the time when the key is read, the key reader number, the key number (1-125), and the result code (0-4). The meaning of the result code is as follows:

- 0 = the presented key is accepted, and the associated door opener or relay output is activated.
- 1 = unknown key
- 2 = no access privilege for the door opener or relay in question

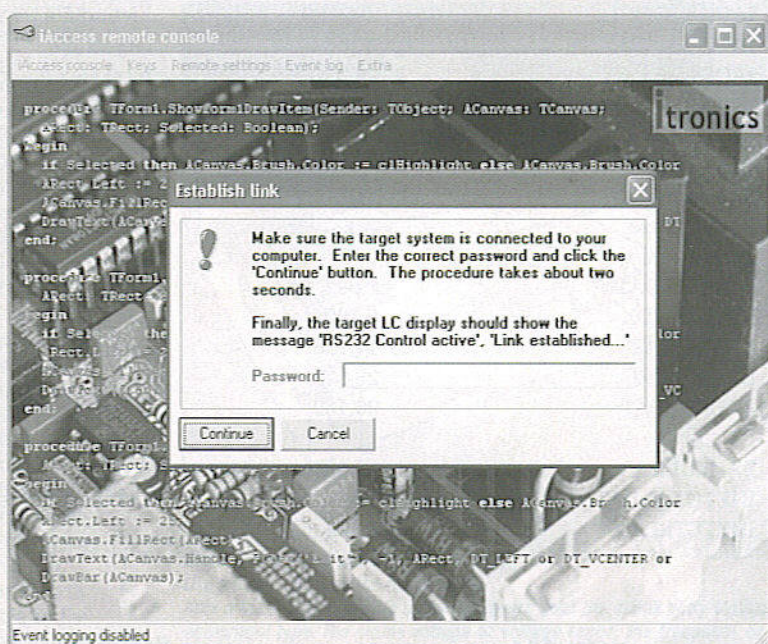

(Level 1)

- 3 = no access privilege for the current day of the week (Level 2)
- 4 = no access privilege outside of the access interval (Level 3)

All of this information can be stored in the computer. This only requires 'Enable event logging' to be activated under the 'iAccess console' menu. If desired, the program can be minimised to an icon in the system tray. It is also possible to start the program in minimised mode, with event logging being immediately active.

In addition to the information shown on the LCD, several other items are recorded in the log file, such as:

- result codes 5 and 6 (warm and cold resets);
- the state of the door opener or relay output (on or off);
- the name of the user (see below);
- the physical key number as engraved on the iButton.

If desired, several additional items can be recorded for each key, such as the name of the user (key holder), key label, date issued, date returned, etc. Summaries of this information can also be printed out if desired. This information is also used in the log file and when the keys are edited in configuration mode.

## Available software for iAccess

(ref. 020163-11.zip, Free Download)

File name	Size	Description
Firmware version 3_5.zip	88,139	Microcontroller source code, version 3.5
Executable 2_2.zip	1,087,471	Windows software for recording events and configuring the access control system, version 2.2
Source 2_2.zip	669,005	Source files for the Windows software (Delphi 5). Note: the source code can only be recompiled using Delphi 5 Professional (or a higher version) with the DBISAM database engine installed; see <a href="http://www.elevatesoft.com">www.elevatesoft.com</a> .

### Content of Firmware version 3\_5.zip

File name	Size	Description
IACC-V35.A51	163,172	Version 3.5 source file

IACC-V35.LST	286,299	Listing file generated by the assembler
IACC-V35.OBJ	7,108	Object file
IACC-V35.HEX	19,692	Intel Hex file for programming the microcontroller

### Content of Executable 2\_2.zip

File name	Size	Description
iConsole.exe	2,300,416	iAccess Remote Console version 2.2 executable file
iconsole.ini	507	Configuration parameters and various settings for iConsole
KEYLOG.DAT	7,807	Database files containing logged event data
KEYLOG.IDX	8,192	
EXTRA.DAT	14,735	Database files containing user data and additional key information
EXTRA.IDX	28,672	
BACKUP.DAT	30,166	Database files for generating and restoring backups of the keys database
BACKUP.IDX	16,384	
INETCTRL.DAT	1,663	Database for receiving external commands via a computer network
INETCTRL.IDX	8,192	

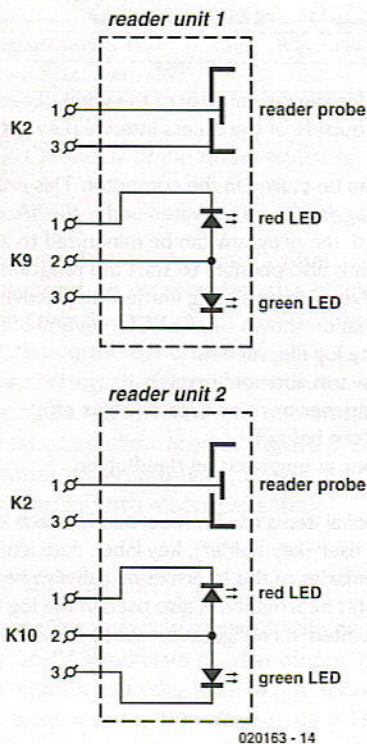

Figure 5. The iButton probes and indicator LEDs (D17–D20) are combined to form two reader units.

for each key and each door opener or relay output. The key can activate the door opener or relay output only during this time period.

Note that access privileges at a higher level take priority over access privileges at a lower level. For example, if a key does not provide access to door opener 1 based on Level-1 access privileges, access is effectively denied

Red LED	Green LED	Meaning
blinking at 0.5 Hz	off	system waiting for a key
off	on	door opener or relay activated
on for 3 s	off	key refused
on	off	system in configuration mode

Table 2. Status LED indications.

to the key regardless of what privileges may be assigned at Level 2 or Level 3.

### Building and connecting reader units

For practical use, the iButton probes must be fitted into robust reader units that can be installed adjacent to a door or other type of entrance.

For the prototype, cast aluminium boxes were used for this purpose. Besides an iButton probe, each box was fitted with red and green status LEDs. The necessary connections are shown in Figure 5.

The wiring between the main circuit board and the reader unit can best be made using standard UTP network cable. Make sure that the terminals of the iButton probe are connected using a single twisted pair in the cable, such as blue and blue/white.

For outdoor applications, you should preferably use a DS9092L probe or possibly a DS9092T probe. The DS9092 model is not suitable for outdoor use, since raindrops can

cause shorts between the outer contact ring and the contact surface in the middle. The iButtons can be fitted into small holders (type DS9093) that are intended to be attached to a key ring and to which a number can be affixed.

Finally, Table 2 provides a brief summary of the indications provided by the status LEDs.

Additional information about iAccess is also available on the author's website at

<http://www.itronics-design.be/>

(020163-1)

## Free Downloads

All project software.

File number: **020163-11.zip**

PCB layout in PDF format.

File number: **020163-1.zip**

[www.elektor-electronics.co.uk/dl/dl.htm](http://www.elektor-electronics.co.uk/dl/dl.htm),

select month of publication.

In all mains-operated equipment certain important safety requirements must be met. The relevant standard for most sound equipment is Safety of Information Technology Equipment, including Electrical Business Equipment (European Harmonized British Standard BS EN 60950:1992). Electrical safety under this standard relates to protection from

- a hazardous voltage, that is, a voltage greater than 42.4 V peak or 60 V d.c.;
- a hazardous energy level, which is defined as a stored energy level of 20 Joules or more or an available continuous power level of 240 VA or more at a potential of 2 V or more;
- a single insulation fault which would cause a conductive part to become hazardous;
- the source of a hazardous voltage or energy level from primary power;
- secondary power (derived from internal circuitry which is supplied and isolated from any power source, including d.c.)

Protection against electric shock is achieved by two classes of equipment.

Class I equipment uses basic insulation; its conductive parts, which may become hazardous if this insulation fails, must be connected to the supply protective earth.

Class II equipment uses double or reinforced insulation for use where there is no provision for supply protective earth (rare in electronics – mainly applicable to power tools).

The use of a Class II insulated transformer is preferred, but note that when this is fitted in a Class I equipment, this does not, by itself, confer Class II status on the equipment.

Electrically conductive enclosures that are used to isolate and protect a hazardous supply voltage or energy level from user access must be protectively earthed regardless of whether the mains transformer is Class I or Class II.

Always keep the distance between mains-carrying parts and other parts as large as possible, but never less than required.

If at all possible, use an approved mains entry with integrated fuse holder and on/off switch. If this is not available, use a strain relief (Figure, note 2) on the mains cable at the point of entry. In this case, the mains fuse should be placed after the double-pole on/off switch unless it is a Touchproof® type or similar. Close to each and every fuse must be affixed a label stating the fuse rating and type.

The separate on/off switch (Figure, note 4), which is really a 'disconnect device', should be an approved double-pole type (to switch the phase and neutral conductors of a single-phase mains supply). In case of a three-phase supply, all phases and neutral (where used) must be switched simultaneously. A pluggable mains cable may be considered as a disconnect device. In an approved switch, the contact gap in the off position is not smaller than 3 mm.

The on/off switch must be fitted by as short a cable as possible to the mains entry point. All components in the primary transformer circuit, including a separate mains fuse and separate mains filtering components, must be placed in the switched section of the primary circuit. Placing them before the on/off switch will leave them at a hazardous voltage level when the equipment is switched off.

If the equipment uses an open-construction power supply which is not separately protected by an earthed metal screen or insulated enclosure or otherwise guarded, all the conductive parts of the enclosure must be protectively earthed using green/yellow wire (green with a narrow yellow stripe – do not use yellow wire with a green stripe). The earth wire must not be daisy-chained from one part of the enclosure to another. Each conductive part must be protectively earthed by direct and separate wiring to the primary earth point which should be as close as possible to the mains connector or mains cable entry. This ensures that removal of the protective earth from a conductive part does not also remove the protective earth from other conductive parts.

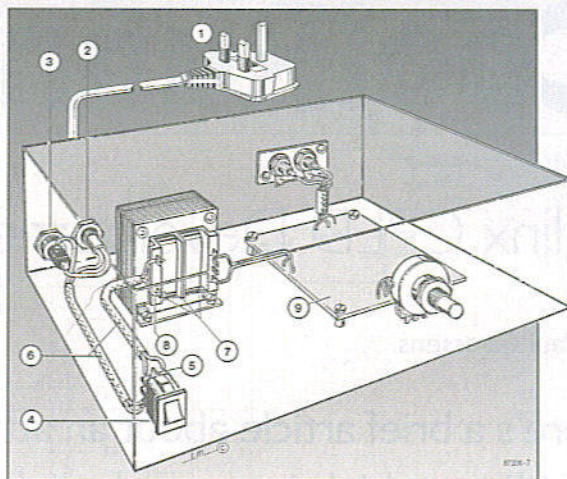

1. Use a mains cable with moulded-on plug.
2. Use a strain relief on the mains cable.
3. Affix a label at the outside of the enclosure near the mains entry stating the equipment type, the mains voltage or voltage range, the frequency or frequency range, and the current drain or current drain range.
4. Use an approved double-pole on/off switch, which is effectively the 'disconnect device'.
5. Push wires through eyelets before soldering them in place.
6. Use insulating sleeves for extra protection.
7. The distance between transformer terminals and core and other parts must be  $\geq 6$  mm.
8. Use the correct type, size and current-carrying capacity of cables and wires – see shaded table below.
9. A printed-circuit board like all other parts should be well secured. All joints and connections should be well made and soldered neatly so that they are mechanically and electrically sound. Never solder mains-carrying wires directly to the board: use solder tags. The use of crimp-on tags is also good practice.
10. Even when a Class II transformer is used, it remains the on/off switch whose function it is to isolate a hazardous voltage (i.e., mains input) from the primary circuit in the equipment. The primary-to-secondary isolation of the transformer does not and can not perform this function.

Pay particular attention to the metal spindles of switches and potentiometers: if touchable, these must be protectively earthed. Note, however, that such components fitted with metal spindles and/or levers constructed to the relevant British Standard fully meet all insulation requirements.

The temperature of touchable parts must not be so high as to cause injury or to create a fire risk.

Most risks can be eliminated by the use of correct fuses, a sufficiently firm construction, correct choice and use of insulating materials and adequate cooling through heat sinks and by extractor fans.

The equipment must be sturdy: repeatedly dropping it on to a hard surface from a height of 50 mm must not cause damage. Greater impacts must not loosen the mains transformer, electrolytic capacitors and other important components.

Do not use dubious or flammable materials that emit poisonous gases.

Shorten screws that come too close to other components.

Keep mains-carrying parts and wires well away from ventilation holes,

so that an intruding screwdriver or inward falling metal object cannot touch such parts.

As soon as you open an equipment, there are many potential dangers. Most of these can be eliminated by disconnecting the equipment from the mains before the unit is opened. But, since testing requires that it is plugged in again, it is good practice (and safe) to fit a residual current device (RCD)\*, rated at not more than 30 mA to the mains system (sometimes it is possible to fit this inside the mains outlet box or multiple socket).

\* Sometimes called residual current breaker – RCB – or residual current current breaker –RCCB.

These guidelines have been drawn up with great care by the editorial staff of this magazine. However, the publishers do not assume, and hereby disclaim, any liability for any loss or damage, direct or consequential, caused by errors or omissions in these guidelines, whether such errors or omissions result from negligence, accident or any other cause.

#### 3-core mains cable to BS6500 1990 with three stranded conductors in thick PVC sheath

Max current	3 A	6 A	13 A
conductor size	16/0.2 mm	24/0.2 mm	40/0.2 mm
Nom cond area	0.5 mm <sup>2</sup>	0.75 mm <sup>2</sup>	1.25 mm <sup>2</sup>
overall cable dia.	5.6 mm	6.9 mm	7.5 mm

#### Insulated hook-up wire to DEF61-12

Max current	1.4 A	3 A	6 A
Max working voltage	1000 V rms	1000 V rms	1000 V rms
PVC sheath thickness	0.3 mm	0.3 mm	0.45 mm
conductor size	7/0.2 mm	16/0.2 mm	24/0.2 mm
Nom cond area	0.22 mm <sup>2</sup>	0.5 mm <sup>2</sup>	0.95 mm <sup>2</sup>
overall wire dia	1.2 mm	1.6 mm	2.05 mm

#### 3-flat-pin mains plug to BS 1363A

# CoolRunner-II

## Xilinx CPLD Development Kit

By Paul Goossens

Here's a brief article about an attractive development kit from our friends at Xilinx, which is not only rich in contents but also affordable for the hobbyist! The board is supplied ready-built and comes with two CD-ROMs crammed with software.



designs but also in hobbyist's projects sent to us for evaluation and eventual publication in *Elektor Electronics*. As we see it, this is not only due to the fact that these components offer far more possibilities than PALs and GALs, but also that nearly all FPGAs and CPLDs are programmable, the relevant manufacturers put free development software at your disposal and — last but not least — *Elektor Electronics* is and remains way ahead of its competitors. Admittedly, a disadvantage of these new chips is that they are usually supplied in SMD cases only.

PALs and GALs never really made it into the world of hobby electronics, despite the fact that these components are instrumental in vast component count reductions, even accepting changes to their contents and so obviating the need to build yet another version of the circuit. Apparently, in the eyes of many hobbyists these advantages do not justify the cost of a suitable programmer, the associated design software and a pile of data books.

CPLDs and FPGAs on the other hand are increasingly found, not only in professional

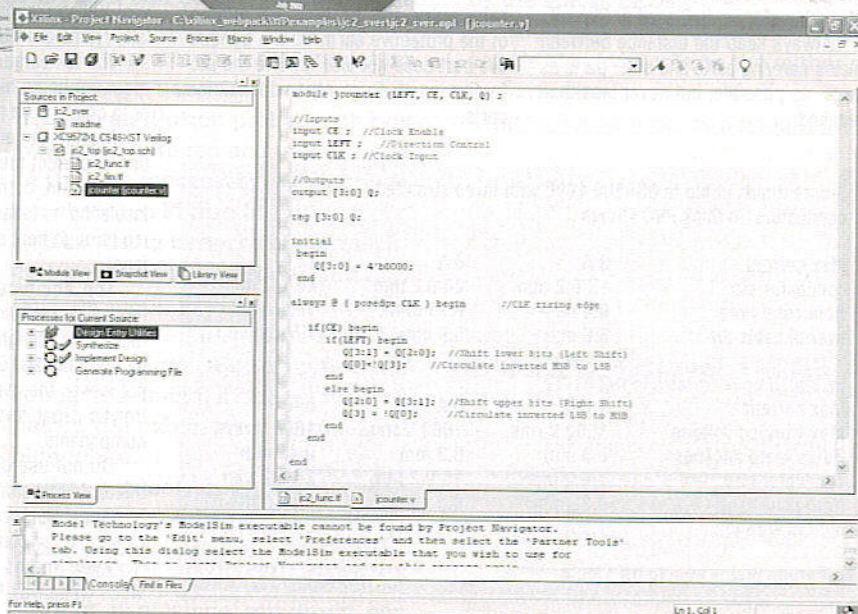

## An extensive package

The one disadvantage we just mentioned is of no consequence if you decide to go for the new development kit from Xilinx. What is called a 'development board' actually comprises of the following elements:

- printed circuit board with a CPLD ready fitted
- parallel cable for programming
- development software (ISE Web-pack) on CD
- resource CD-ROM crammed with information
- *Programmable Logic Guide*
- battery holder

However, the most remarkable thing about this kit is not its contents but its price of just 50 US dollars plus shipping, which means that it should be possible to have one delivered to your doorstep in the UK for about 65 pounds. This price, we feel, really defeats almost any attempt at home construction (just consider the cost and effort that goes into making the board...). Availability is no problem either: simply order your kit directly from the Xilinx Internet shop which also welcomes private customers, using the link:

[www.xilinx.com/xlnx/xebiz/online-store.jsp?sGlobalNavPick=PURCHASE](http://www.xilinx.com/xlnx/xebiz/online-store.jsp?sGlobalNavPick=PURCHASE)

On this page, click on 'Development Boards' and then on 'CoolRunner-II Boards'. This will take you to the page showing the development kit covered by this article.

## The hardware

The printed circuit board comes with a CPLD type XC2C256TQ144-7 fitted ex-factory. If desired, a second CPLD may be fitted on the board — this may be an XC2C64 or an XC2C32. An oscillator running at 1.8432 MHz supplies the clock signal required by the CPLDs. The oscillator module is fitted in an IC socket allowing it to be easily exchanged if a different clock frequency is in order. In your choice of the oscillator module, do bear in mind the pin connections and the supply voltage (3.3 V).

The power supply may be a DC adapter (mains eliminator) or a bat-

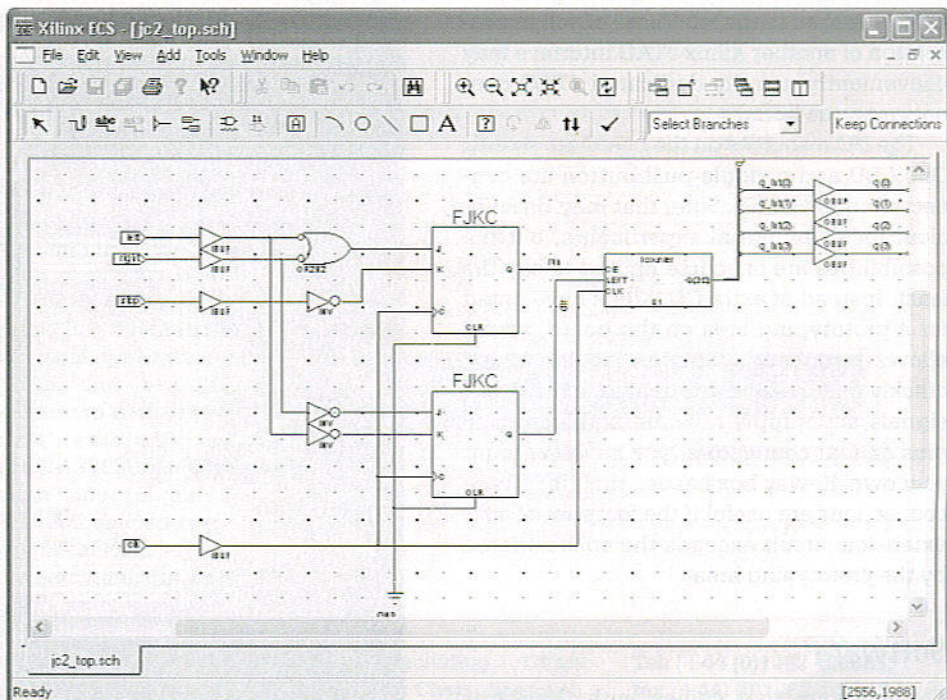

tery. Depending on your choice, JP1 may have to be relocated. If an external supply greater than 3.3 V is used, the jumper has to be in the 'Int' position (internal stabilisation). When two series-connected 1.5-volt batteries are used, JP1 needs to be moved to the 'Ext' (external stabili-

sation) position. As shown by the indication, the supply voltage is not stabilised in the second case. If a too high supply voltage is applied, components may be damaged (as we learned the hard way), so be careful!

A 25-way sub-D connector is provided to be able to program CPLDs. This connector is linked to the parallel port on the PC using the



cable supplied in the kit. Those of you in possession of another Xilinx JTAG interface may conveniently use the dedicated JTAG connector on the board.

The I/O resources on the board are scanty. One LED and a single pushbutton are connected to the CPLD. Sure, that may be sufficient for a few initial experiments, but the possibilities are of course limited to say the least. Instead of extra I/O, Xilinx have opted for a prototyping area on the board, which allows peripheral hardware to be added quickly and easily. Furthermore, all relevant signals and supply rails are bonded out to pins on four connectors (you have to mount your own 40-way box header, though). These connections are useful if the footprint of your extension circuit exceeds the space offered by the prototyping area.

## Software

The software that comes with the kit is extremely extensive and distributed across two CD-ROMs. The design software and a number of examples may be found on the CD-ROM labelled 'ISE'. The other CD-ROM contains a multimedia presentation about the development board, together with some additional technical information.

In our case the ISE software suite contained version 5.1. Meanwhile, updates have become available on the Xilinx website, and all users of the kit are encouraged to get these free downloads. During installation you are prompted to register ownership of the product, which is possible by Internet, fax or e-mail.

Within ISE, designs may be entered in a number of ways: Verilog and VHDL are the two languages the software understands. Besides, the software contains its own schematic capture utility that allows a circuit to be drawn in a more conventional way. The state machine editor is a nice bonus feature thrown in by the people at Xilinx. This editor takes the hassle out of designing a state machine. Just draw it, enter the right conditions and hey presto the software generates a valid VHDL file. If you're after bugs or improvements, analysing and/or modifying such a state machine is much easier than examining just about any piece of VHDL code.

Fortunately, ISE also contains a tutorial providing step-by-step guidance on how the software is best used. As usual, it is recommended to complete the tutorial to the very end. Doing so will eventually save you a lot of time searching for the desired function.

To cap it all, ISE also contains a program that allows a CPLD to be easily programmed

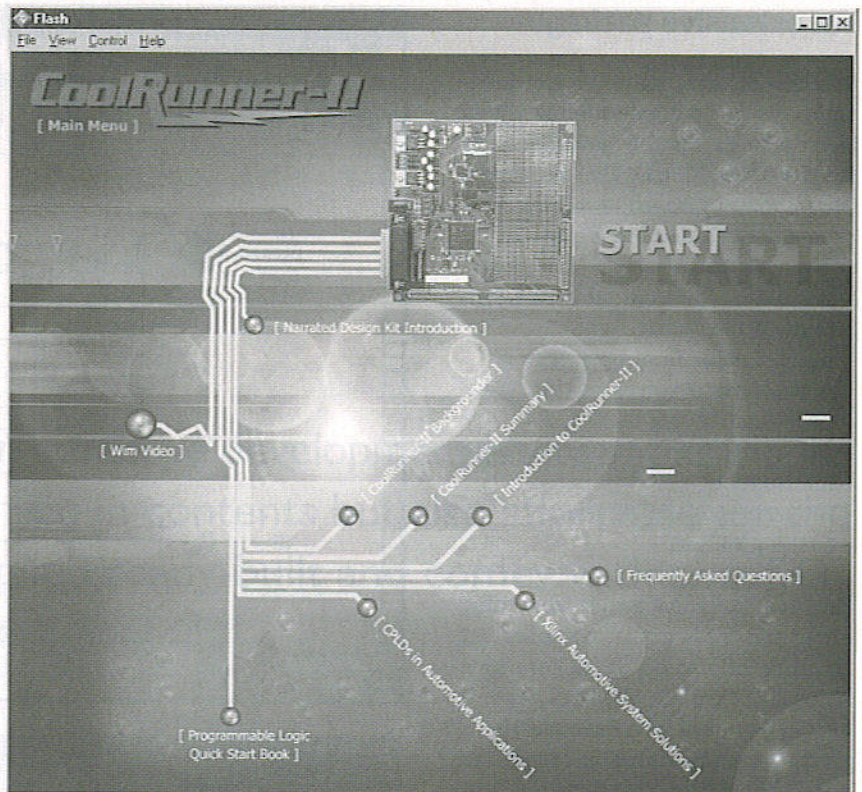

from a PC. In this way, the entire programming cycle is dealt with by a single software package.

## Finally

This development kit is highly recommended if you are interested in CPLDs, or just want to gain experience in describing circuitry in the Verilog or VHDL language. On their website Xilinx also offers a considerable number of free examples for use with ISE. The price of the Xilinx CoolRunner-II kit, its availability and ease of ordering are first-rate and we

hope other suppliers of development kits will follow suit.

Here at the *Elektor Electronics* editorial offices we are curious to know what, if any, circuits you have put together using this brilliant development kit, so do let us know if you think you have something worthwhile to show us. Our mailbox, [editors@elektor-electronics.co.uk](mailto:editors@elektor-electronics.co.uk) is kept spam-free so has plenty of room for your designs!

In closing we wish you lots of fun with your CPLD experiments.

(030427-1)

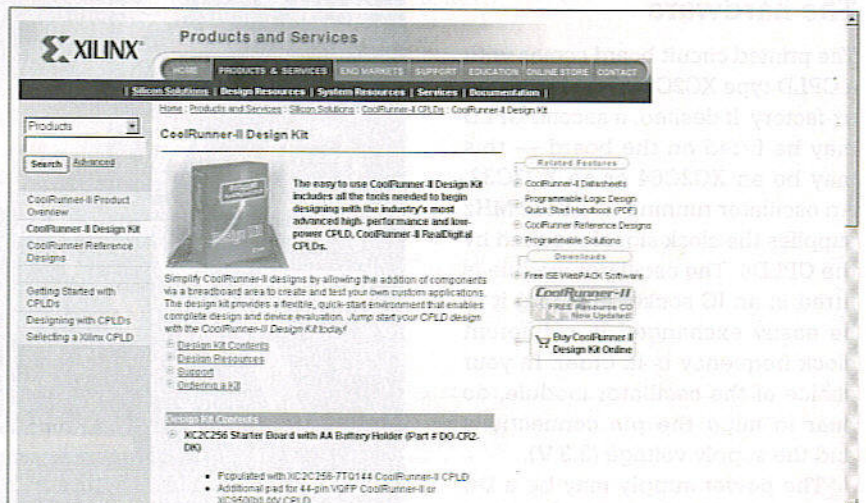

## DASYLAB LITE

Big or small budget — straightforward or complex application — here's a version of DASYLab to suit most needs. So now everyone can access legendary usability and make their data acquisition set-up a success the DASYLab way!

DASYLab has made setting up PC-based data acquisition systems easier and faster than ever before. And it doesn't take a programmer or prior knowledge of working with this kind of graphical data acquisition software to be able to use DASYLab straight away — it comes with an excellent 'getting started' tutorial and is extremely user-friendly. But if money is tight, and the full version of DASYLab is a little beyond the budget, it's no longer necessary to make do with a more 'clunky', less usable software alternative.

Now with a new lower price, just £425 plus delivery and VAT, DASYLab Lite is the most affordable way to access the acclaimed functionality and ease of use that makes DASYLab the first choice for Windows-based data acquisition. It takes just a few minutes to create individual applications with DASYLab and even the most sophisticated acquisition and control tasks can be solved with DASYLab quickly and without any programming. All that's needed is to connect graphical icons representing the hardware, the signal processing and the chosen display.

Users can benefit from real-time display and logging, a pre/post trigger module to make it easy to capture areas of interest in your data. DASYLab Lite also supports RS232 inputs and has a wide range of

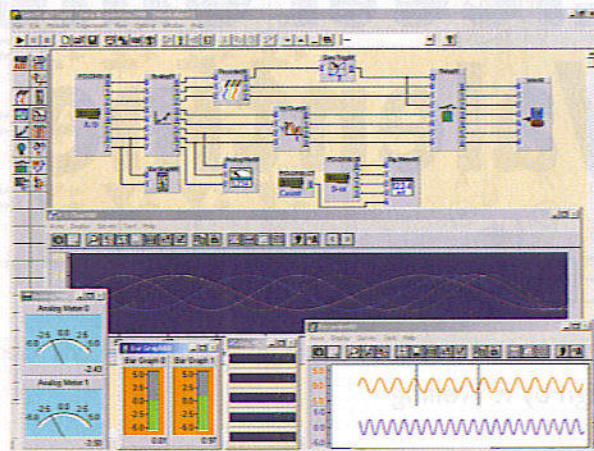

displays including Chart Recorder, Y/t Chart, Bargraph and Meters.

**Adept Scientific plc,**  
Amor Way, Letchworth,  
Herts. SG6 1ZA

Tel. (+44 (0)1462 480055,  
fax (+44 (0)1462 480213  
E-mail  
[daq@adeptsience.co.uk](mailto:daq@adeptsience.co.uk)  
Web:  
[www.adeptsience.co.uk](http://www.adeptsience.co.uk)

(037167-1)

Advertisement

## PC or Laptop portable measuring instruments...

**Resolution - 8bits**  
**Sample Rates -**  
1,2,5,10,20 Ms/s models



£119 ex vat/pp  
(1 Ms/s model)

**NEW!**

**Resolution Menu - 12,14, or 16bits**  
**Sample Rates -**  
5,10,25,50 Ms/s models



£435 ex vat/pp  
(5 Ms/s model)

### Handyprobe HP2 - 1 Ch.

- ✓ Oscilloscope
- ✓ Spectrum Analyzer
- ✓ Voltmeter plus!
- ✓ Transient Recorder
- ✓ Parallel Port
- ✓ Windows OS- all

### Handyscope HS3 - 2 Ch.

- ✓ Oscilloscope
- ✓ Spectrum Analyzer
- ✓ Voltmeter plus!
- ✓ Transient Recorder
- ✓ Arbitrary Waveform Gen.
- ✓ Two hi-z probes 1:1~1:10
- ✓ USB 1.1 or 2.0
- ✓ Windows OS- all

**iTp** Ltd. 28 Stephenson Road, Industrial Estate, St. Ives, Cambs. PE27 3WJ Tel: 01480 460028 Fax: 460340

[info@itp101.com](mailto:info@itp101.com) [www.itp101.com](http://www.itp101.com) [www.tiepie.com](http://www.tiepie.com)

# Electronic Valentine Heart

LEDs are red my dear...

Design by F. Wolling

Although this month's Mini Project is not exactly stunning from a technical point of view, there are a number of unusual sides to it, mainly regarding why and how it came to be published in this issue. Read on...



lots of flowers to the newly weds.

The oldest literary evidence for Valentine's Day being associated with (secret) love may be found in 14<sup>th</sup> century writings, as well as in some of Shakespeare's sonnets and plays.

*Unusual aspect no. 2:* The designer of this circuit, Florian Wolling, was 14 years old when he sent us his article proposal — making him the youngest external author ever to make it to publication of a Mini Project.

*Unusual aspect no. 3:* Originally, this project did not stand a chance of getting published in *Elektor Electronics*. Just like all contributions and other article proposals we receive from free-lance authors, Florian's papers were 'evaluated for publication value' during a meeting of editors and design staff. Although the project met with praise for the meticulous way the circuit, the circuit board and the documentation had been designed and presented, and despite the fact that the small heart-shaped LED ornament was 'charming', the manuscript was rejected for publication because the complete

*Unusual aspect no. 1:* This is the first Valentine circuit ever to be published in *Elektor*, and no, the highstreet flower shops are not to blame if that is the first you associate with Valentine's Day.

Valentine's Day is reportedly the day we 'celebrate' the beheading of a priest called Valentinus on 14 February 270. The execution orders came from an oppressive emperor

called Claudius Gothicus (a.k.a. Claudius II). According to some sources, Valentinus was a bishop and the 14<sup>th</sup> of February a popular Roman holiday. The legend of Saint Valentine tells us the martyr was executed for illicit marrying of Christian couples, the occasions being marked by Valentinus presenting



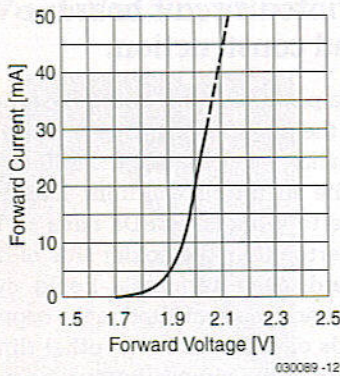

Figure 1. Typical U/I characteristic of a red LED.

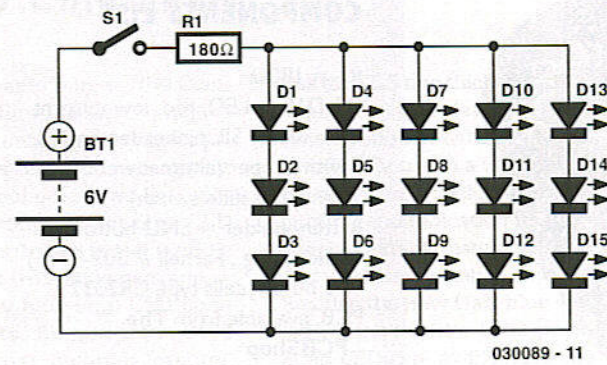
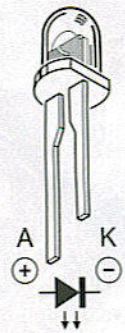

Figure 2. The circuit: one resistor and 15 LEDs.



project was found rather too simple for our demanding readership. However, when writing a letter informing Florian about the rejection of his project, still encouraging him to send further projects in the future, one of our fellow editors suddenly recognised the simple arrangement of LEDs on a board as the perfect circuit for Valentine's Day. Having discovered that such a circuit had not been 'done' before in our magazine, and because Elektor editors are always open to novelties, the LED Heart was added to our forward planning schedule. So, here it is, although one more thing should be noted...

*Unusual aspect no. 4:* The Elektor designer assigned with the technical preparation of Florian's project (mainly to make it meet our design standards), could not resist doing his bit of post-engineering. Admittedly, there's not you can change drastically

when looking at one resistor and a bunch of paralleled LEDs, but improvements and fine tuning are always possible. The difference between Florian's LED Heart and the Elektorised version boiled down to the components used. Apparently, Florian was encouraged to use SMD LEDs by our two-part article 'SMDs — Don't Panic!' in the January and February 2003 issues of *Elektor Electronics*. The resulting project, he thought, would make an excellent gift as well present a convincing exercise to win over those readers still hesitant about their own skills in handling these tiny components. The latter aspect has been crossed out, however, because the Elektorised version of the project employs normal size components, not only with an aim to make the project easier to reproduce for beginners, but also to prevent component sourcing problems. Because all components except the LEDs are soldered at the rear side of

the board, only the LED faces are visible from the front, allowing the front side of the board to be painted or sprayed in whatever way you like. For our own prototype, we happened to have some red paint left...

### Circuit and component calculations

As most of you will know, there are few, if any, applications of LEDs that do not include some form of current limiting resistor. After all, LEDs are simply diodes that light when a forward bias voltage is applied across them. They also 'exhibit' the typical diode characteristic shown in **Figure 1**. If you apply a slowly rising voltage starting at 0 V to a LED, such that the device conducts (+ to anode; - to cathode), you will notice that nothing happens for quite a while — no current appears to flow. However, once the voltage exceeds a critical level, current starts to flow, rising very quickly when the voltage is increased further. This so-called threshold voltage occurs at 0.6 V with normal silicon diodes and at 1.6 V with most LEDs (as in **Figure 1**). A value of 1.7 V will be noted when testing low-current LEDs in this way. Without a current limiting resistor, a small increase of the voltage beyond the threshold voltage would mean imminent destruction of the LED because the forward current rises extremely fast and soon exceeds the 'safe' level.

With a resistor in series with the LED, things look different because according to Ohm's law, the resistor becomes the main current determining factor. In the circuit of the Electronic Valentine Heart (**Figure 2**) five strings of series-connected LEDs are connected in parallel. Each string consists of three LEDs. The voltage across each of these strings equals three times the forward conducting voltage of a single LED. Assuming a device voltage of 1.7 V we get

## 'High Efficiency' LEDs

Light Emitting Diodes (LEDs) have been around for a long time — the first LEDs were mass-produced around 1975. The luminosity of red LEDs is specified by the manufacturer at a current of 10 mA or 20 mA (depending on type). These current eaters are hardly used anymore (at least not in Elektor circuits), because red LEDs with a much higher efficiency are now available. These successor types light happily at a current of just 2 mA (similar green LEDs are specified at 4 mA or 5 mA). Because of their improved efficiency, these LEDs are referred to as 'High Efficiency' types in some professional publications. The classification 'Low-Current' is however more commonly found in catalogues, datasheets and articles. Such LEDs are perfectly suitable for low currents of the order of 1-3 mA and are clearly visible in indoor applications when operated at just under 1 mA (as in the project described in this article). Besides, who would use the Electronic Valentine Heart in the glare of the February sun?

## Printed circuit board and construction.

The printed circuit board designed for the project is single-sided. The 3-mm holes in it enables the LED faces to be seen from the front side. For this to work the LEDs have to be inserted from the solder side of the board, their terminals being cut, bent and then soldered to the copper pads on the board. The other three parts in the circuit (battery holder, resistor and a 3-way SIL pinheader) are soldered in SMD fashion to the track side of the board. The battery holder is actually the only SMD component. Instead of the soldered battery holder you may, of course, use a separate holder (for example, containing two AA cells) and connect it to the board via wires.

When soldering the LEDs onto the board, make sure you get their polarity right. As indicated in the circuit diagram, the cathode is the shorter of the two wires. This (negative) connection is marked by the bar in the diode symbol.

Our prototype is switched on by relocating a jumper on the 3-way SIL pinheader. For a more sophisticated approach to on/off switching, a miniature slide switch is recommended.

## Finally

If you have been wondering all the time why the Electronic Valentine Heart does not blink just like most other LED ornaments, brooches and trinkets, well, it happens to be *Unusual Aspect no. 5*. There's nothing to stop you making the LEDs blink, though, just consider borrowing the flip-flop element from our 'LED Christmas Decoration' (December 2003).

(030089-1)

## COMPONENTS LIST

- RI = 180Ω
- D1-D15 = LED, red, low-current
- SI = 3-way SIL pinheader, angled, with jumper (alternative: miniature slide switch)
- Battery holder = SMD button cell holder (e.g., Farnell # 302-9785)
- Two button cells type CR2032
- PCB, available from **The PCBShop**

button cells. If the voltage across the LED strings is 5.1 V, the resistor is accountable for the voltage difference between the two voltages at its terminals. The difference works out at  $5.9 \text{ V} - 5.1 \text{ V} = 0.8 \text{ V}$ . From this value we can calculate the current as

$$0.8 \text{ V} / 180 \Omega = 0.00444 \text{ A} = 4.44 \text{ mA}$$

This current is supplied by the battery, flowing through the resistor and the LEDs. Because all LEDs are of the same type and the voltage across each string is also equal, it is safe to assume that the current is equally divided across the five LED strings. Hence, the current through each individual LED equals

$$4.44 \text{ mA} / 5 = 0.89 \text{ mA}$$

Not a lot, you may think, but sufficient for a low-current LED to light with reasonable brightness. If the circuit was modified such that all LEDs are connected in parallel, the current consumption from the battery would be three times as high (assuming the same LED current is maintained). The load on the battery would then become about 13 mA, which is rather heavy on the button cells used. Besides, the difference in brightness between individual LEDs would be far more noticeable than with the series-connected version.

If you would like to know more about LEDs and how they can be used in large clusters, you should get a copy of our article 'LED Arrays' from the April 2003 issue of *Elektor Electronics*. The Internet is also a good source for additional information on LED calculations, see 'Web Pointers' at the end of this article.

## Web Pointers

- [ourworld.compuserve.com/homepages/Bill\\_Bowden/led.htm](http://ourworld.compuserve.com/homepages/Bill_Bowden/led.htm)
- <http://linear1.org/ckts/led.php>
- [www.electronics2000.co.uk/calc/calcded.htm](http://www.electronics2000.co.uk/calc/calcded.htm)
- [www.hamradioindia.com/HRI-Calc/LEDcalc.htm](http://www.hamradioindia.com/HRI-Calc/LEDcalc.htm)

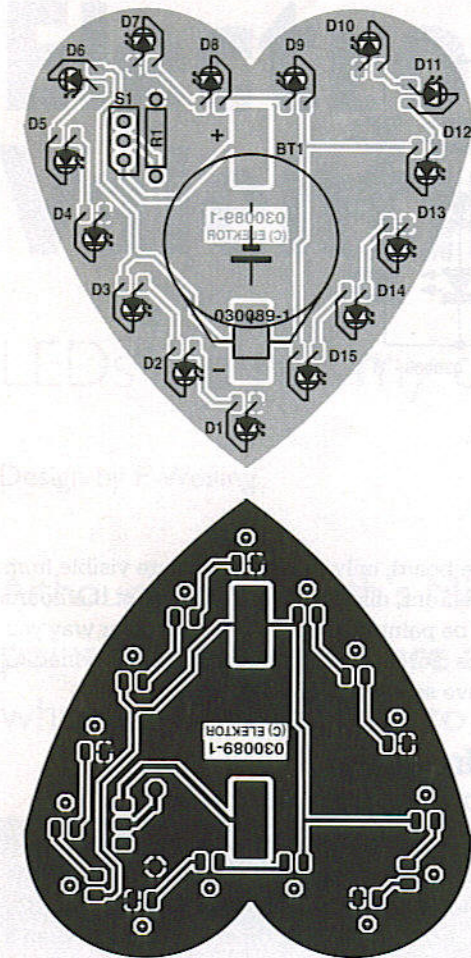
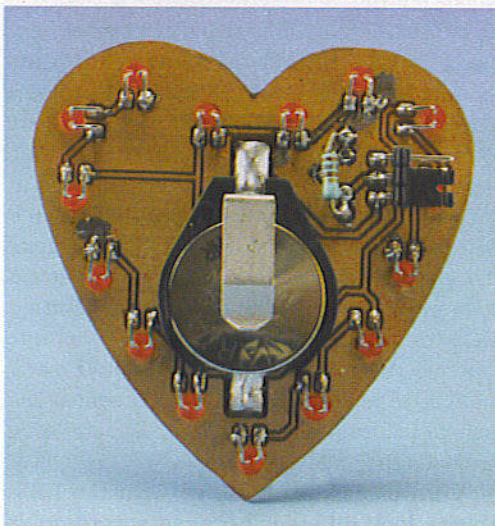

Figure 3. The heart-shaped board (insert LEDs from track side).



$$3 \times 1.7 \text{ V} = 5.1 \text{ V}$$

The LEDs are connected to the battery by way of a 180-Ω resistor. Although the battery voltage is 6 V nominally ( $2 \times 3 \text{ V}$ ), we should use the value 5.9 V to account for the load on

## World's Smallest SMD Chip LEDs

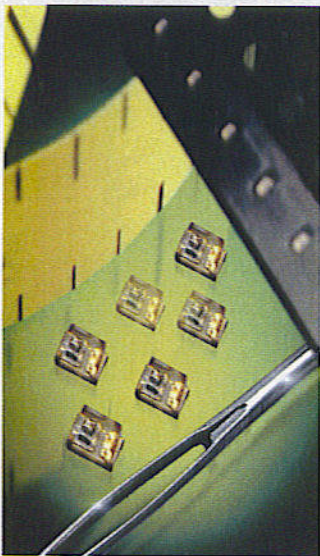

Components Bureau, the Cambridgeshire-based passive components and specialist capacitor distribution company, has launched a new low cost blue surface mount chip LED from Kingbright in the world's smallest 0402 style package. The new blue chip LED complements Kingbright's 0402 range that includes orange, yellow, green and super-bright red indicators with typical light outputs of 140 mcd at 20 mA. The new GaN LED chip offers the luxury of blue indication in applications at a fraction of the cost of traditional blue SMD devices. Measuring just 1.0 x 0.5 mm and

less than 0.5 mm thick, the LEDs feature a water-clear lens with viewing angle of 120 degrees and are ideal for use in a wide range of applications including backlighting and indication in lightweight, portable instrumentation and telecommunication devices. Besides the new GaN blue version, Kingbright's 0402 packaged LEDs are available in the full spectrum of colour (430 to 700 nm) and brightness (All-nGaP to InGaN technology). Depending on colour, specifications include power dissipation from 75 to 170 mW, DC forward current of 30 mA peak forward current from 150 to 195 mA, reverse voltage of 5 V and oper-

ating temperature range from -40 to +85 degrees C. The 0402 style LEDs are capable of withstanding reflow soldering temperatures up to 230 degrees C for up to 10 s and 140 to 160 degrees C for up to 120 s. All Kingbright 0402 style chip LEDs are supplied on tape and reel in quantities of 2000 pieces.

**Components Bureau Ltd.,  
Vision House,  
11 Bramley Road, St Ives,  
Cambridgeshire, PE27 3WS.  
Tel.: +44 (0)1480 386565  
Fax: +44 (0)1480 386566.  
Web:**

[www.componentsbureau.com](http://www.componentsbureau.com)

(047012-5)

## CAN Code Creation Wizard



Utilising its ColdFire Development Suite and Code Creation Wizards, Crossware can create from scratch embedded CAN programs for Motorola's Cold-

Fire MCF5282 microcontroller in just under 1 minute and 34 seconds.

"It is difficult to explain in words just how easy and quick it is to create a CAN program using our Development Suite," said Alan Harry, Crossware's founder and CEO. "Consequently, we decided to record the whole process so that developers can see exactly how it's done. The complete video lasts less than 2 minutes and can be viewed along with the source code that the Wizard generates."

Crossware's ColdFire Develop-

ment Suite includes a number of Code Creation Wizards to help the programmer write code for the MCF5282 microcontroller. The CAN Code Creation Wizard is particularly useful because setting up the CAN controller registers and message buffers is normally a complicated process. However, using Crossware's CAN Code Creation Wizard the programmer can build a complete functional program that will transmit and receive CAN messages without any previous experience and with no learning curve. Not a single line of

code has to be written. Developers can view a demonstrator video at <http://www.crossware.com/can>. An evaluation version of Crossware's ColdFire Development Suite can also be downloaded allowing programmers to generate complete CAN programs of their own.

**Crossware, Old Post House,  
Silver Street, Litlington,  
Royston, Herts, SG8 0QE, UK.  
Tel. + 44 (0) 1763 853500,  
fax + 44 (0) 1763 853330.  
Web: [www.crossware.com](http://www.crossware.com)**

(047012-8)

## A Chip in the Old Block



Now you can buy a potted LED block with all the features of a

voltmeter built in. Lascar Electronics has added to its range of low-cost, ultra-miniature panel instruments with the introduction of the OEM 1B-LED.

This module is a 3½-digit, LED voltmeter with a 9-mm digit

height that combines low current consumption with a compact body design no bigger than a standard LED block. Supplied in an encapsulated, compact DIL package, the OEM 1B-LED can be easily integrated into applications where space constraints exist and the full functionality of a voltmeter many times its size is required. Features of the OEM 1B-LED include selectable decimal points, auto-polarity, auto-zero and 200 mV full scale reading with on board calibration.

The module's low cost makes it an attractive option with prices starting at £15.50 (volume discounts available).

**Lascar Electronics Limited,  
Module Hose, Whiteparish,  
Salisbury, Wiltshire SP5 2SJ.  
Tel. (+44) (0)1794 884567,  
Fax (+44) (0)1794 884616.  
Web:**

[www.lascarelectronics.com](http://www.lascarelectronics.com)

(047012-2)

# Danbury Electronics

**U.K. Manufacturers & designers of quality Transformers for over 20 years.**

- IVA-750VA size range, medium quantities
- Mains, Audio, Loudspeaker & ferrite types
- Specialise in Valve/Tube mains and output transformers.
- Rewind/Replacement of rare/special transformers
- A standard range of Valve/Tube Amp mains & Output Tx's (P/P, SE etc) is available through Mike Holme's web site:  
[www.mc-h.demon.co.uk/transformers.html](http://www.mc-h.demon.co.uk/transformers.html) (Also, Valve circuits, Parts lists, Chassis & Advice)
- Established supplier to Maplin Electronics ([www.maplin.co.uk](http://www.maplin.co.uk)) for over 15 years.

Contact David Brooks I.Eng MIE (Proprietor)

**Phone : 01245 328174**

**Fax: (24Hr) 01245 328963**

**Email: DanburyElecTX@aol.com**

20 Cutlers Rd, Saltcoats Ind. Estate,  
South Woodham Ferrers, Essex. CM3 5XJ (UK)

# The Simple Solution! FlexIt

AVR Modular Development System

- Based on the Atmel AVR controller
- Flexible and powerful
- Simple to configure
- Very compact

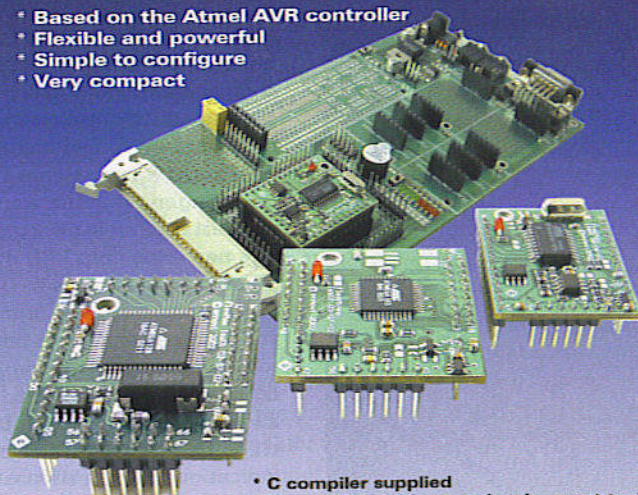

- C compiler supplied
- Compatible with most development tools
- In-system programmable
- Free Atmel debug simulator available
- Peripheral drivers and libraries supplied
- Increasing range of expansion modules
- Full web site support

Check out FlexIt at [www.ennovi.co.uk](http://www.ennovi.co.uk)

**ennovi ltd**  
*Dynamic Design*

+44 (0)1425 478884  
[sales@ennovi.co.uk](mailto:sales@ennovi.co.uk)

Precision measurement  
Embedded control  
Intrinsic safety  
Internet embedded systems  
USB interface

## CD-ROM FREWARE & SHAREWARE 2003

ELEKTOR CD-ROMs



£12.05 (US\$ 21.25)  
ISBN 90-5381-169-9

Just like previous editions, the crop of 2003 supplies all ingredients to allow the modern electronics kitchen to cook and serve a wide range of recipes ranging from appetizers and cocktail snacks right up to the main dish, not forgetting salads and desserts, of course. The ingredients are hundreds of programs that can be run on various operating systems, linked directly or indirectly to electronics in general, programming, microcontrollers for sure, but also to many allied areas.

Besides the usual sections (CAD, Audio, Calculation Tools, Programming, Simulation, etc.) the 2003 edition of the Freeware & Shareware CD-ROM contains a collection of 'must-haves' which are not specifically linked to electronics, but valuable when it comes to writing or manipulating programs and files (assembly code, C, Delphi and others). This collection comprises utilities like *xnView* (for graphics file visualisation), *dirprint* (file, directory and subdirectory listing), *Total Commander* (previously known as *Windows Commander*) and other ingenious tidbits covering functions like file renaming.

**NEW**

Order now using the Order Form in the Readers Services section in this issue

Elektor Electronics (Publishing) • P.O. Box 190 • Tunbridge Wells TN5 7WY  
• England. Telephone +44 (0) 1580 200 657 • Fax +44 (0) 1580 200 616

**ELEKTOR ELECTRONICS**  
THE ELECTRONICS & COMPUTER MAGAZINE

See also  
[www.elektor-electronics.co.uk](http://www.elektor-electronics.co.uk)



Quasar Electronics Limited  
PO Box 6935, Bishops Stortford,  
CM23 4WP  
Tel: 0870 246 1826  
Fax: 0870 460 1045  
E-mail: sales@quasarelectronics.com

Add £2.00 P&P to all UK orders. 1st Class Recorded - £4.  
Next day (Insured £250) - £7. Europe - £5. Rest of World - £10.  
We accept all major credit/debit cards. Make cheques/PO's  
payable to Quasar Electronics Limited.  
Prices include 17.5% VAT. MAIL ORDER ONLY.  
Call now for our FREE CATALOGUE containing details of  
over 300 electronic kits, projects and modules.



**QUASAR**  
electronics

**0871**

**CREDIT CARD  
SALES**

**717 7168**

### Motor Drivers/Controllers

Here are just a few of our controller and driver modules for AC, DC, unipolar/bipolar stepper motors and servo motors. See website for full details.

#### DC Motor Speed Controller (5A/100V)

Control the speed of almost any common DC motor rated up to 100V/5A. Pulse width modulation output for maximum motor torque at all speeds. Supply: 5-15VDC. Box supplied. Dimensions (mm): 60Wx100Lx60H. Kit Order Code: 3067KT - **£12.95**  
Assembled Order Code: AS3067 - **£19.95**

#### NEW! PC / Standalone Unipolar Stepper Motor Driver

Drives any 5, 6 or 8-lead unipolar stepper motor rated up to 6 Amps max. Provides speed and direction control. Operates in stand-alone or PC-controlled mode. Up to six 3179 driver boards can be connected to a single parallel port. Supply: 9V DC. PCB: 80x50mm. Kit Order Code: 3179KT - **£9.95**  
Assembled Order Code: AS3179 - **£16.95**

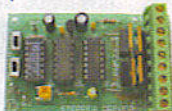

#### PC Controlled Dual Stepper Motor Driver

Independently control two unipolar stepper motors (each rated up to 3 Amps max.) using PC parallel port and software interface provided. Four digital inputs available for monitoring external switches and other inputs. Software provides three run modes and will half-step, single-step or manual-step motors. Complete unit neatly housed in an extended D-shell case. All components, case, documentation and software are supplied (stepper motors are NOT provided). Dimensions (mm): 55Wx70Lx15H. Kit Order Code: 3113KT - **£15.95**  
Assembled Order Code: AS3113 - **£24.95**



#### NEW! Bi-Polar Stepper Motor Driver

Drive any bi-polar stepper motor using externally supplied 5V levels for stepping and direction control. These usually come from software running on a computer. Supply: 8-30V DC. PCB: 75x85mm. Kit Order Code: 3158KT - **£12.95**  
Assembled Order Code: AS3158 - **£26.95**



Most items are available in kit form (KT suffix) or assembled and ready for use (AS prefix).

### Controllers & Loggers

Here are just a few of the controller and data acquisition and control units we have. See website for full details. Suitable PSU for all units: Order Code PSU203 £9.95

#### Rolling Code 4-Channel UHF Remote

State-of-the-Art. High security. 4 channels. Momentary or latching relay output. Range up to 40m. Up to 15 Tx's can be learnt by one Rx (kit includes one Tx but more available separately). 4 indicator LED's. Rx: PCB 77x85mm, 12VDC/6mA (standby). Two and Ten channel versions also available. Kit Order Code: 3180KT - **£41.95**  
Assembled Order Code: AS3180 - **£49.95**



#### Computer Temperature Data Logger

4-channel temperature logger for serial port. °C or °F. Continuously logs up to 4 separate sensors located 200m+ from board. Wide range of free software applications for storing/using data. PCB just 38x38mm. Powered by PC. Includes one DS1820 sensor and four header cables. Kit Order Code: 3145KT - **£22.95**  
Assembled Order Code: AS3145 - **£29.95**  
Additional DS1820 Sensors - **£3.95 each**



#### NEW! DTMF Telephone Relay Switcher

Call your phone number using a DTMF phone from anywhere in the world and remotely turn on/off any of the 4 relays as desired. User settable Security Password, Anti-Tamper, Rings to Answer, Auto Hang-up and Lockout. Includes plastic case. 130x110x30mm. Power: 12VDC. Kit Order Code: 3140KT - **£39.95**  
Assembled Order Code: AS3140 - **£59.95**



#### Serial Isolated I/O Module

PC controlled 8-Relay Board. 115/250V relay outputs and 4 isolated digital inputs. Useful in a variety of control and sensing applications. Uses PC serial port for programming (using our new Windows interface or batch files). Once programmed unit can operate without PC. Includes plastic case 130x100x30mm. Power: 12VDC/500mA. Kit Order Code: 3108KT - **£54.95**  
Assembled Order Code: AS3108 - **£64.95**

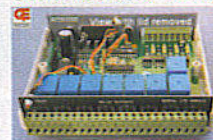

#### Infrared RC Relay Board

Individually control 12 on-board relays with included infrared remote control unit. Toggle or momentary. 15m+ range. 112x122mm. Supply: 12VDC/0.5A  
Kit Order Code: 3142KT - **£41.95**  
Assembled Order Code: AS3142 - **£59.95**

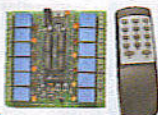

### PIC & ATMEL Programmers

We have a wide range of low cost PIC and ATMEL Programmers. Complete range and documentation available from our web site.

#### Programmer Accessories:

40-pin Wide ZIF socket (ZIF40W) **£15.00**  
18V DC Power supply (PSU201) **£5.95**  
Leads: Parallel (LEAD108) **£4.95** / Serial (LEAD76) **£4.95** / USB (LEADUAA) **£4.95**

#### NEW! USB 'All-Flash' PIC Programmer

USB PIC programmer for all 'Flash' devices. No external power supply making it truly portable. Supplied complete with 40-pin wide-slot ZIF socket, box and Windows Software. Kit Order Code: 3128KT - **£49.95**  
Assembled Order Code: AS3128 - **£54.95**



#### Enhanced "PICALL" ISP PIC Programmer

Will program virtually ALL 8 to 40 pin PICs plus a range of ATMEL AVR, SCENIX SX and EEPROM 24C devices. Also supports In-System Programming (ISP) for PIC and ATMEL AVRs. Free software. Blank chip auto detect for super fast bulk programming. Requires a 40-pin wide ZIF socket (not included). Kit Order Code: 3144KT - **£54.95**  
Assembled Order Code: AS3144 - **£59.95**

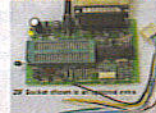

#### ATMEL 89xxxx Programmer

Uses serial port and any standard terminal comms program. 4 LED's display the status. ZIF sockets not included. Supply: 16-18VDC. Kit Order Code: 3123KT - **£29.95**  
Assembled Order Code: AS3123 - **£34.95**



#### NEW! USB & Serial Port PIC Programmer

USB/Serial connection. Ideal for field use. Header cable for ICSP. Free Windows software. See website for PICs supported. ZIF socket not incl. Supply: 18VDC. Kit Order Code: 3149KT - **£29.95**  
Assembled Order Code: AS3149 - **£44.95**



**www.quasarelectronics.com**



Secure Online Ordering Facilities Full Product Listing, Descriptions & Photos Kit Documentation & Software Downloads

# Easy-PC for Windows

## World Beating Value in PCB Design Software

from  
**£97**

High performance Windows based PCB Design Capture, Simulation and Layout software at prices you'd expect from your local computer store!

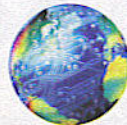

**NEW!** in Easy-PC 7

- Library Databook
- Step and repeat plotting
- Swap Connection Mode
- Dimensioning
- Copy to Metafile plus much more.....

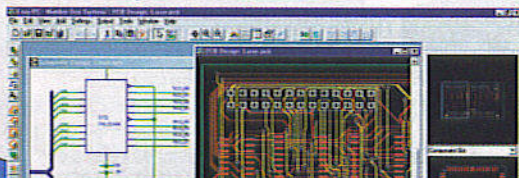

**Stop press...** by customer demand, now with Tsien Boardmaker 2 design import...

Number One Systems delivers true 32 bit Windows software applications including features that a few short years ago would only have been available in software tools priced in the thousands!

Test drive Easy-PC and Easy-Spice for yourself and be prepared to be amazed at the super value...

Call for a brochure, price list and demo CD on +44 (0)1684 773662 or email [sales@numberone.com](mailto:sales@numberone.com)

**No.1 Number One Systems**

Number One Systems  
Oak Lane, Bredon  
Tewkesbury, Glos GL20 7LR  
United Kingdom

or download from

**[www.numberone.com](http://www.numberone.com)**

## COMPLETE YOUR 30X CIRCUITS SERIES NOW

**302 circuits**

**304 CIRCUITS**

**305 CIRCUITS**

**307 CIRCUITS**

### SUMMER CIRCUIT COMPILATION BOOKS

The 30x series of Summer Circuit compilation books have been bestsellers for many years. You can use these books not only for building the circuits described, but also as a treasure trove of ideas or circuit adaptations for your own experiments. Since the series was started in the early 1980s, many readers have found in these books that new approach, new concept, or new circuit they were looking for. Not surprisingly, our 30x books are now firmly established as collector's items, and carefully preserved by thousands of professionals and hobbyists around the globe. Circuits and design ideas included for: audio, video, music, car, bicycle, home, garden, games, radio, software, test and measurement, PC and peripherals, power supplies, computer hardware, and more. 300 Circuits, 301 Circuits, 303 Circuits and 306 Circuits are now out of print.

#### 302 Circuits

354 pages, size 14 x 21 cm, soft cover  
ISBN 0-905705-25-4  
RRP £10.35 (US\$21.00)

#### 304 Circuits

366 pages, size 17 x 23.5 cm, soft cover  
ISBN 0-905705-34-3  
RRP £13.45 (US\$27.00)

#### 305 Circuits

369 pages, size 17 x 23.5 cm, soft cover  
ISBN 0-905705-36-X  
RRP £15.55 (US\$31.00)

#### 307 Circuits

342 pages, size 17 x 23.5 cm, soft cover  
ISBN 0-905705-62-9  
RRP £18.20 (US\$37.00)

#### 308 CIRCUITS

367 pages, size 17 x 23.5 cm, soft cover  
ISBN 0-905705-66-1  
RRP £18.20 (US\$ 37.00)

**308 CIRCUITS**

**NEW**

Order now using the Order Form in the Readers Services section in this issue

Elektor Electronics (Publishing) • P.O. Box 190 • Tunbridge Wells TN9 7WY  
• England. Telephone +44 (0) 1580 200 657 • Fax +44 (0) 1580 200 616

**ELEKTOR ELECTRONICS**  
THE ELECTRONICS & COMPUTER MAGAZINE

See also  
[www.elektor-electronics.co.uk](http://www.elektor-electronics.co.uk)

# PCB-POOL®

SERVICING YOUR COMPLETE PROTOTYPE NEEDS

- Prototypes at a fraction of the cost
- Tooling and setup included
- Any contour
- Fr4 1.6mm, 35µm Cu
- Industry standard quality
- Follow up series runs
- CAM / CAD consulting

PRICE EXAMPLE:  
**EUROCARD DS/PTH**

- + Tooling
- + Photoplots
- + VAT

**£ 29.89\***

\*Sterling rates may vary. Price = €49

**€49**

**FREE**

with your order  
(while stocks last)



may differ slightly  
to model shown

**beta**  
CIRCUIT

Tel: +353 (0)161 701170  
Fax: +353 (0)161 701164  
E-Mail: sales@beta-kyout.com

Freephone

**0800-389 8560**

Simply send your files and order ONLINE:

**WWW.PCB-POOL.COM**

TARGET **PreTel** **ORcad** **GraphiCode** **PROTELS** **Electronics**

## Kit Radio Company

**Kits! Kits!  
With All the Bits!  
Our kits include**



Labeled and drilled case! hardware! Step by step instructions!  
Even Batteries! £10 Get U going service available!

<b>KRC-1</b>	4 band superhet built in 5 easy Steps MW 160, 80 and 40 meters	<b>£59.99</b>
<b>KRC-2</b>	General coverage receiver 1-10 11-20 20-30 MHZ	<b>£49.99</b>
<b>KRC-3</b>	VHF receiver FM broadcast band and aircraft band	<b>£49.99</b>
<b>KRC-A-1</b>	Morse code practice oscillator Works with any MW receiver	<b>£11.99</b>
<b>KRC-A-2</b>	90 volt battery replacement Solid state inverter with sleep mode	<b>£29.99</b>
<b>KRC-A-3</b>	Active antenna tuner 1-30 MHZ in 4 bands 20db gain	<b>£49.99</b>

Send S.A.E. for full details. Or visit our web site.  
<http://hometown.aol.co.uk/kitradioco/uk.htm>

Order direct from KRC  
Unit II, Marlborough Court,  
Westerham, Kent. TN16 1EU  
Tel 01959 563023

Postage & Packing  
UK £4.00  
Europe £8.00  
U.S.A. £12.00

## ELEKTOR-METER PRECISION MEASUREMENT CENTRAL

ELEKTOR HARDWARE & SOFTWARE

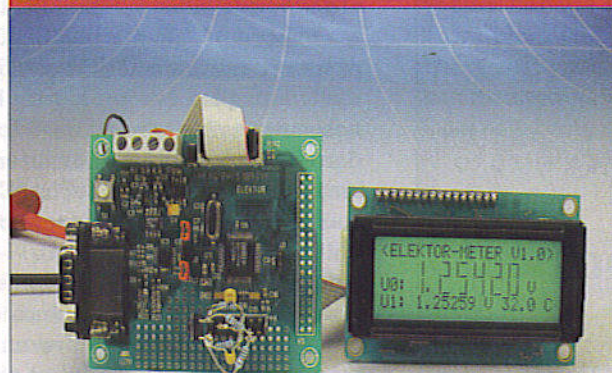

We can offer the ready-manufactured, populated and calibrated board for just **£ 69.00 / \$ 112.50 (plus P&P)**

### BASED ON THE MSC1210 DEVELOPMENT SYSTEM

In the July/August 2003 issue we started a series of articles based on the Texas Instruments MSC1210 microcontroller. Thanks to this contemporary controller and its 24-bits A-D converter, the development system can be programmed for lots of applications and measurement functions. Among these is a high-accuracy digital meter with no less than 5½ digits and 8 analogue inputs. All you have to do to build the instrument is add an LCD!

Because the MSC1210 microcontroller comes in an SMD case with 0.5-mm (0.02 in.) pin spacing, soldering the device properly with DIY tools is almost impossible. That's why we are offering the development board as a ready-manufactured unit only.

Elektor Electronics (Publishing) • P.O. Box 190 • Tunbridge Wells TN9 7WY  
• England. Telephone +44 (0) 1580 200 657 • Fax +44 (0) 1580 200 616

**ELEKTOR  
ELECTRONICS**  
THE ELECTRONICS & COMPUTER MAGAZINE

See also  
[www.elektor-electronics.co.uk](http://www.elektor-electronics.co.uk)

# Remote Control for your PC

With a home-made infra-red receiver

By Harry Baggen

With the PC seeing increasing use as a multimedia machine, recording and playing back video and audio, users will soon want to control a number of functions remotely, just as with their TV or hi-fi set. All you need to realise this is a standard infra-red remote control unit, a home-brew receiver circuit and some software.

Quick preview. Click on it to see the full resolution scheme

Components list:

- U1 - 74HC14 (datasheet from [National Sem](#))
- U2 - 74HC132 ([National](#))
- U3 - IS1U69L or GP1U52X ([Sharp, Radio Shack](#))
- U4 - 74HC393 ([National](#))
- U5 - 74HC165 ([National](#))
- U6 - DS14C232 or MAX232 ([National, Maxim](#))
- R1,2 - 1K ohm resistor
- R3 - 22K ohm potentiometer
- C1,2 - 1 nF capacitor
- C3 - 4.7 nF capacitor
- C4,7 - 1 nF capacitor
- Serial port connector ([pin1](#), [PC232 info](#))
- 5 volts / 20 mA power source ([max232](#))

**Design modifications**, contributed by [Robert Maurer](#): It uses only the 74HC14 IC. It seems to work better and specially for large distances. These minor changes affect to the Load, Reset and Clock signal generation. You can also try his [circuit suggestion](#) to drain off the power from the serial port (untested).

A number of manufacturers in the consumer electronics sector supply remote controls with special receivers — the complete kit allowing a PC to be controlled from a distance. In many cases, the remote control includes a kind of mouse replacement so you can even move the cursor around on the

screen. The infra-red (IR) receiver usually consists of a small receiver module for connecting to the PC's serial port by way of a cable. The supplied software then looks after the processing of received IR signals. In many cases, a remote control set

is included with a TV card for the PC, although the features then remain limited to a number of essential TV and radio functions.

Fortunately, several alternatives are now available to link a PC to a remote control. Thanks to a number of clever programmers and some really simple hardware it has become possible to use a dead standard remote control transmitter to realise remote control on your PC.

The receiver is, of course, home built, which — we are sure — is unlikely to present problems to readers of *Elektor Electronics*. Incidentally, if you happen to have an IR remote control lying around, say, from a TV card system, you'll find that this may often be used without problems in combination with the programs discussed below.

On the Internet you'll find a variety of articles and web pages discussing home construction of an IR receiver. The designs vary in complexity from five-component 'interfaces' right up to microcontroller-driven gadgets. In all cases, however, you'll have to build up a small circuit. When a microcontroller is used, we



found that in the majority of cases the hex code to program your own MCU is freely available.

**How to build an IR Receiver** by Alessio Sangalli [1] provides extensive explanations and clear photographs, allowing even beginners to assemble their own IR receiver without too much of an effort. Alessio's design is simple by any standard, consisting of an IR receive module, a voltage regulator and three passive components.

Similar designs, also rich in illustrations and with detailed descriptions may be found on the **Heatseekerz** website [2]. The author, Tom de Keninck, sets a standard how an electronic construction can be described on web pages. The photographs Tom shows us, in combination with a step-by-step approach and the assumption that the reader knows virtually nothing all contribute to the excellent reproducibility of the circuit.

**The Infrared PC Remote Control** — **Info page** [3] aims a bit wider. Here, we found several receivers discussed — designs with and without microcontrollers. The site also discusses the necessary software and proposes some ready to go solutions. We also found a download link to the shareware program 'PC Remote Control'.

A receiver circuit based on a PIC12C508/509 is discussed at the **UIR page** [4]. The author shows how the circuit may be built from standard components as well as SMDs (surface mount devices).

**The Universal Remote Control Receiver** [5] is a project built around a PIC16F84. According to the description, it is suitable for nearly all commercially available remote controls. Both the microcontroller hex code and the PC layout are available to everyone wishing to build this design. The designer also offers the associated software, DRCS (Dalton Remote Control Software), to run on your PC.

A similar circuit based on the previous design is called the **Universal IR-receiver for serial interface** [6] and may be found on the web pages of the electronics faculty at the University of Ulm, Germany.

Besides hardware (a remote control transmitter and a matching

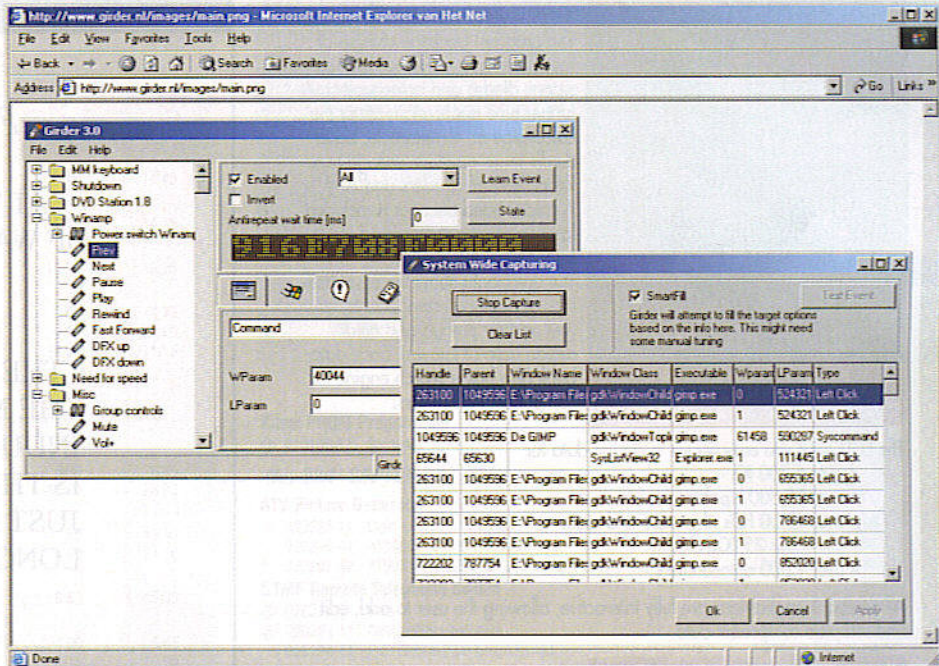

receiver) you'll also need software to detect and process the serial data, as well as convert it to commands the PC can understand. A universal program that looks after these tasks is called **LIRC** (Linux Infrared Remote Control) [7]. A Windows version of the program is available from the **WinLIRC** homepage [8].

**Girder** [9] is also a well-known *Windows automation tool* (shareware) capable of recognising and employing lots of remote control signalling formats for linking to Windows programs and PC hardware. The sheer popularity of this program has resulted in many exotic IR formats now being supported thanks to

the contributions of active users. If you don't believe us, just take a look at the list of available plug-ins!

**IRAssistant** [10], which comes free of charge for private use, also allows mouse movement to be mimicked using the remote control, as well as launch and control programs, run macros, all from the comfy chair.

Finally, we should mention **uICE** [11] by MediaTexX. This shareware is also rich in features when it comes to driving hardware and software. The program is marked by an Office-like user interface, offering an on-screen menu and on-screen display looking very much like the ones you see on modern TV sets.

(045012)

## Internet Addresses

- [1] How to build an IR receiver: <http://lnx.manoweb.com/lirc/>
- [2] Heatseekerz - remote control: [www.heatseekerz.net/index.php?page=articles&id=4&pagenum=1](http://www.heatseekerz.net/index.php?page=articles&id=4&pagenum=1)
- [3] Infrared PC Remote Control - Info Page: [www.geocities.com/CapeCanaveral/Lab/1475/remotectrl.html](http://www.geocities.com/CapeCanaveral/Lab/1475/remotectrl.html)
- [4] UIR - Universal Infrared Receiver: <http://fly.cc.fer.hr/~mozgic/UIR/>
- [5] Dalton Electronics - URRCR: [www.dalton-electronics.com/URCR/URCR.aspx](http://www.dalton-electronics.com/URCR/URCR.aspx)
- [6] Universal IR-receiver, Microelectronics Department, University of Ulm: <http://mikro.e-technik.uni-ulm.de/research/lurcr.html>
- [7] LIRC - Linux Infrared Remote Control: [www.lirc.org/](http://www.lirc.org/)
- [8] WinLIRC Homepage: <http://winlirc.sourceforge.net/>
- [9] Girder: [www.girder.nl/](http://www.girder.nl/)
- [10] IRAssistant: [www.irassistant.com/dotcom/v\\_current/](http://www.irassistant.com/dotcom/v_current/)
- [11] MediaTexX Software Solutions: [www.mediatexx.com/](http://www.mediatexx.com/)

# ECD

ELEKTOR'S COMPONENTS DATABASE

Internet [www.elektor-electronics.co.uk](http://www.elektor-electronics.co.uk)

Compiled by L. Libertin

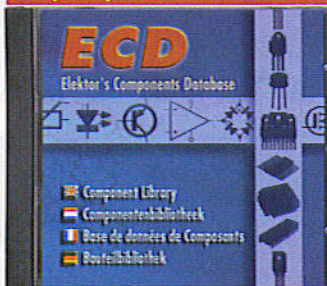

£12.95 (US\$ 22.90)

Minimum computer requirements:  
Pentium II, min. 133 Mhz; Min. Windows 95; Min. 32 MB RAM; Min. 260 MB free space on hard disk.

The ECD gives you easy access to design data for

- over 5,300 ICs
- over 22,500 bipolar transistors
- over 4,900 FETs, thyristors and triacs
- just under 25,000 diodes
- over 1,800 optocouplers

All databank applications are fully interactive, allowing the user to add, edit and complete component data.

**ORDER NOW USING THE ORDER FORM  
IN THE READERS SERVICES SECTION, OR  
WRITE TO**

P.O. Box 190 • Tunbridge Wells TN5 7WY • England  
Telephone +44 (0) 1580 200 657 • Fax +44 (0) 1580  
200 616

**ELEKTOR  
ELECTRONICS**  
THE ELECTRONICS & COMPUTER MAGAZINE

The program package consists of four databanks covering ICs, transistors, diodes and optocouplers. A further nine applications cover the calculation of, for example, zener diode series resistors, voltage regulators, voltage dividers and AMV's. A colour band decoder is included for determining resistor and inductor values. The databanks show the case drawings of nearly all components, as well as their pinouts and quick design data (if known). Each databank also has a search engine for component parameters.

## BOOK THIS DATE IN YOUR DIARY NOW

FRIDAY MAY 7

AT THE UNIVERSITY  
OF WARWICK, COVENTRY

' THE FUTURE OF  
THE MICROELECTRONICS  
INDUSTRY IN EUROPE:  
IS THE CURRENT UPTURN  
JUST A BLIP OR PART OF  
LONG TERM TREND ? '

Watch out for details in the  
Subsequent issues of Elektor  
And on our website.

# Gameboy Digital Sampling Oscilloscope

ELEKTOR HARDWARE & SOFTWARE



The ready built GBDSO board costs £ 90.00 including the associated PC software and the magazine articles

## BACK IN STOCK!

The GBDSO (Gameboy Digital Sampling Oscilloscope), published in Elektor Electronics October and November 2000 is still in great demand.

The GBDSO is a plug-in module that turns the popular Nintendo Gameboy Classic, Colour or Advanced into a versatile dual-channel oscilloscope. An optional link to a PC even allows measured oscillograms to be viewed or stored on the PC. The GBDSO comes as a ready-built and tested PCB and may be ordered via our website:  
[www.elektor-electronics.co.uk](http://www.elektor-electronics.co.uk)

The ready built GBDSO board costs £ 90.00 including the associated PC software and the magazine articles (published in the October and November 2000 issues).

Order now on [www.elektor-electronics.co.uk](http://www.elektor-electronics.co.uk)

Elektor Electronics (Publishing) • P.O. Box 190 • Tunbridge Wells TN5 7WY  
• England. Telephone +44 (0) 1580 200 657 • Fax +44 (0) 1580 200 616

**ELEKTOR  
ELECTRONICS**  
THE ELECTRONICS & COMPUTER MAGAZINE

See also  
[www.elektor-electronics.co.uk](http://www.elektor-electronics.co.uk)

## Please Note

Software items marked @ are available from the Free Downloads page of the Publishers' website at [www.ektor-electronics.co.uk](http://www.ektor-electronics.co.uk). Diskettes are supplied for the convenience of readers without Internet access.

### EVERGREENS

	£	US \$
<b>Elektronics Help Disk</b>		
966022-1 Disk, Windows version	8.15	14.45
<b>Elektronics Item Tracer 1985-2002</b>		
036003-11 contents database (disk, Windows version)	8.15	14.35
<b>Medium power HEXFET amplifier (December 1993)</b>		
930102-1 PCB	10.90	19.25
<b>Universal Prototyping Boards</b>		
UPBS-1 PCB	2.45	4.30
UPBS-2 2 PCBs	4.10	7.25
UPBS-4 4 PCBs	6.55	11.55

### No. 329 - February 2004

<b>Digital Alarm Clock</b>		
@ 030096-11 Disk, PIC source and hex code	4.90	8.65
030096-41 PIC16F84-04/p, programmed	15.20	26.90
<b>iAccess</b>		
@ 020163-11 Disk set, source code and control software	7.50	13.30
020163-41 AT89S8252-12PC, programmed	13.90	24.60
<b>Simple 12-to-230V Power Inverter</b>		
@ 020435-1 PCB	8.50	15.05
<b>Touch-controlled Switch</b>		
@ 030214-11 Disk, PIC source code	4.90	8.65
030214-41 PIC12C508A04/S08, programmed	6.15	10.90

### No. 328 - JANUARY 2004

<b>64-K 80C552 Flash Board</b>		
@ 030042-1 PCB	9.35	16.55
@ 030042-11 Disk, misc. project software	4.90	8.65
030042-21 29F010, programmed	10.00	17.70
030042-31 GAL 16V8D150P, programmed	6.10	10.80
<b>Climate Logger</b>		
@ 030076-1 PCB	7.75	13.70
@ 030076-11 Disk, Windows software	4.90	8.65
<b>FMS Flight Simulator Encoder</b>		
@ 030066-1 PCB	10.20	18.05
030066-41 87LPC767BN, programmed	17.05	30.15
<b>LED Roulette</b>		
@ 030168-1 PCB	17.90	31.60
@ 030168-11 Disk, source and hex files	4.90	8.65
030168-41 89C2051-12PC, programmed	8.05	14.25

<b>Multi-event Alarm Clock</b>		
@ 020304-11 Disk, C (source) hex files	4.90	8.65
020304-41 AT89C2051-12PC, programmed	6.10	10.80

<b>Stepper Motors Uncovered</b>		
020127-41 PIC16F873-20/SP	19.10	33.80

### No. 327 - DECEMBER 2003

<b>FM Remote Control Transmitter &amp; Receiver</b>		
@ 034044-1 PCB	10.20	18.05
<b>LED Christmas Decoration</b>		
@ 030157-1 PCB	7.55	13.35
<b>P87LPC76x Programmer</b>		
@ 030313-11 Disk, project software	4.90	8.65
<b>Project Timekeeper</b>		
@ 020350-11 Disk, source & object code files	4.90	8.65
020350-41 PIC16F84-10P, programmed	13.15	23.25
<b>Stepper Motors Uncovered (2)</b>		
@ 020127-11 Disk, source code file	4.90	8.65
<b>Universal Clock Generator</b>		
@ 020395-11 Disk, source code file	4.90	8.65
<b>Wireless RS232 Link</b>		
@ 030204-1 PCB	8.70	15.40

### No. 326 - NOVEMBER 2003

<b>Rev Counter for R/C Models</b>		
@ 024111-1 PCB	17.50	31.00
024111-11 Disk, source and hex code	4.90	8.65
024111-41 89C2051-12PC, programmed	8.85	15.65
<b>Running Text Display</b>		
@ 020407-11 Disk, source and hex code	4.90	8.65
<b>USB Analogue Converter</b>		
@ 020374-1 PCB	7.65	13.50
@ 020374-11 Disk, hex code and Windows software	4.90	8.65
020374-41 PIC16C765, programmed	13.25	23.45

### No. 325 - OCTOBER 2003

<b>DDS RF Signal Generator</b>		
@ 020299-1 PCB, generator	11.60	20.55
@ 020299-2 PCB, control/supply	12.10	21.45
020299-41 AT90S8515 8PC, programmed	30.55	54.05
<b>Minimalist Induction-Balance Metal Detector</b>		
@ 020290-1 PCB	8.95	15.85

### GENERAL

Printed-circuit boards (PCBs), self-adhesive front panel foils, ROMs, EPROMs, PALs, GALs, microcontrollers and diskettes for projects which have appeared in *Elektronics* may be ordered using the Order Form printed opposite. The form may also be used to order books (private customers only).

> The artwork for making a PCB which is not available ready-made through the Readers Services may be found in the relevant article.

> EPROMs, GALs, PALs, (E)PLDs, MACHs, PICs and other microcontrollers are supplied ready-programmed.

Prices and item descriptions subject to change. The publishers reserve the right to change prices without prior notification. Prices and item descriptions shown here supersede those in previous issues. E. & O.E.

### PAST ISSUES

Past issues, if available, should be ordered from **Worldwide Subscription Service Ltd, Unit 4, Gibbs Reed Farm, Pashley Road, TICEHURST TN5 7HE, England, telephone (+44) 1580 200657, fax (+44) 1580 200616, email [wwss@wwss.demon.co.uk](mailto:wwss@wwss.demon.co.uk)**. Prices of past issues (except July/August and December), including postage for single copies, are £4.75 (UK and Eire); £5.30 (air mail Europe); £6.10 (airmail outside Europe). Prices of past July/August and December issues, including postage for single copies, are £6.65 (UK and Eire); £7.35 (airmail Europe); and £8.45 (airmail outside Europe).

### PAST ARTICLES

For information on past articles, please contact our Editorial and Administrative Offices, telephone (01580) 200657; fax 200616, email [sales@ektor-electronics.co.uk](mailto:sales@ektor-electronics.co.uk).

	£	US \$
<b>Xilinx PROM Programmer</b>		
@ 010109-11 Software	4.90	8.65

### No. 324 - SEPTEMBER 2003

<b>ATV Picture Generator</b>		
@ 020295-11 Disk, source & hex code files	4.90	8.65
020295-41 AT90S8515-8PC, programmed	15.20	26.90
020295-42 AT90S1200-12PC, programmed	13.90	24.60

<b>DTMF Remote Telephone Switch</b>		
@ 020294-1 PCB	11.65	20.60
@ 020294-11 Disk, project software	4.90	8.65
020294-41 PIC16F84A-20/P, programmed	14.70	26.00

<b>LC Display with I2C Bus</b>		
@ 030060-2 PCB	7.35	13.00

<b>PICProg 2003</b>		
@ 010202-1 PCB	9.05	16.00
@ 010202-11 Disk, Windows software	4.90	8.65
010202-41 PIC16F874-20/P, programmed	23.55	41.65

<b>Polyphonic Doorbell</b>		
@ 020354-11 Disk, project software	4.90	8.65
020354-41 PIC16F84A-10/P, programmed	14.45	25.55

<b>Precision Measurement Central</b>		
030060-91 Ready-assembled & tested board	69.00	112.50

<b>Valve Pre-amplifier (1)</b>		
@ 020383-1 PCB, amplifier board	11.55	20.40
@ 020383-2 PCB, power supply board	11.40	20.20
@ 020383-3 PCB, I/O board	10.10	17.80

### No. 323 - JULY/AUGUST 2003

<b>Add a Sparkle</b>		
@ 020293-11 Disk, HEX and source files	4.90	8.65
020293-41 PIC12C509A-04/SM, programmed	7.40	13.10

<b>AT90S2313 Programmer</b>		
@ 034036-1 PCB	9.05	16.00

<b>Hard Disk Selector</b>		
@ 034050-1 PCB	9.45	16.75

<b>Mini Running Text Display</b>		
@ 020365-11 Disk, source code file	4.90	8.65

<b>Mini Test Chart Generator</b>		
@ 020403-11 Disk, PIC source code	4.90	8.65

<b>Programming Tool for AtTiny15</b>		
@ 030030-1 PCB	7.55	13.35
@ 030030-11 Disk, project software	4.90	8.65

<b>Quad Bridge Car Amp</b>		
@ 034039-1 PCB	8.70	15.35

<b>Remote Light Control with Dimmer</b>		
@ 020337-11 Disk, HEX and source files	4.90	8.65
020337-41 AT89C2051-12, programmed	6.25	11.05

<b>No. 322 - JUNE 2003</b>		
----------------------------	--	--

<b>AVR TV Tennis</b>		
@ 030026-1 Main PCB	8.70	15.40
@ 030026-2 Pushbutton PCB	8.60	15.25
@ 030026-11 Disk, AVR source code	4.90	8.65
030026-41 AT908515, programmed	15.20	26.90

<b>Electronic Knotted Handkerchief</b>		
@ 020308-11 Disk, PC and controller software	4.90	8.65
020308-41 AT90S2313-10PC, programmed	12.60	22.30

<b>Low-Cost LCD Controller (2)</b>		
@ 020114-1 PCB	8.70	15.35
@ 020114-11 Disk, project software	4.90	8.65

<b>Night Light Control</b>		
@ 020115-11 Disk, hex and source code	4.90	8.65
020115-41 AT90S2313-10PC, programmed	12.85	22.75

<b>Universal XA Development Board</b>		
@ 010103-1 PCB	13.20	23.35
@ 010103-11 Disk, GAL code, EPROM hex files, XADEV	4.90	8.65
010103-21 EPROM IC8, 27C256-90, programmed	10.10	17.70
010103-22 EPROM IC9, 27C256-90, programmed	10.00	17.70
010103-31 GAL 16V8, programmed	4.80	8.50

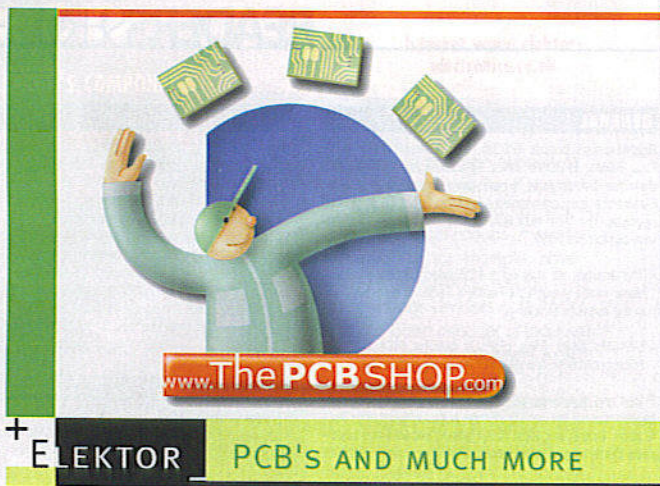

## READERS SERVICES

£ US \$

### Optimise your PC Soundcard

@ 020184-11 Disk, Excel spreadsheet 4.90 8.65

### No. 317 JANUARY 2003

#### Active Loudspeaker System (1)

@ 020054-1 PCB 6.90 12.20

#### Electronic RPG Dice Roller

@ 020005-1 PCB 10.05 17.75

@ 020005-11 Disk, source code file 4.90 8.65

@ 020005-41 AT90S4433-8PC, programmed 30.80 54.50

#### Rodent Deterrent

@ 020110-1 PCB 12.05 21.30

#### SMS-Controlled Mains Sockets

@ 020157-1 PCB 12.90 22.85

### No. 316 DECEMBER 2002

#### DCI PLC

@ 010113-1 PCB, converter board 8.40 14.85

@ 010113-2 PCB, terminal board 12.50 22.10

@ 010113-11 Disk, project software & source code 4.90 8.65

@ 010113-41 AT90S8515-8PC, programmed 21.20 37.55

#### Port Line and ADC Extension

@ 020307-11 Disk, BASCOM-51 programs 4.90 8.65

#### Programmable Dial-Out Blocking Device

@ 020106-1 PCB 12.20 21.55

@ 020106-11 disk, project software 4.90 8.65

@ 020106-41 AT89C2051-1, programmed 6.50 11.50

#### USB Audio Codec with S/PDIF

@ 020178-1 PCB 11.10 19.60

### No. 315 NOVEMBER 2002

#### Audio Level Check for Line Input

@ 020189-1 PCB 9.25 16.35

#### EPROM Emulator

@ 024066-1 PCB 9.35 16.50

@ 024066-11 Disk, GAL JEDEC listing 4.90 8.65

@ 024066-31 GAL 16V89, programmed 5.00 8.65

#### LED Torch

@ 012019-11 Disk, project software 4.90 8.65

@ 012019-41 PIC12C672-04/SM, programmed 10.40 18.40

#### Stand-Alone EEDTS Pro

@ 020125-1 PCB 15.35 27.15

#### Telephone Baby Monitor

@ 012016-1 PCB 10.00 17.70

@ 012016-11 Disk, source and hex files 4.90 8.65

@ 012016-41 AT90S1313-10PC, programmed 10.40 18.40

#### Vehicle Diagnostics Adapter

@ 020138-1 PCB 9.25 16.35

### No. 314 OCTOBER 2002

#### AT90S8535 Programmer

@ 024051-1 PCB 9.05 16.05

#### Digital RF Wattmeter

@ 020026-1 PCB 12.85 22.70

@ 020026-11 Disk, source code files 4.90 8.65

@ 020026-41 PIC16F876-04/SP 19.90 35.20

#### Motorcycle Theft Alarm

@ 000191-1 PCB 9.90 17.50

@ 000191-11 Disk, source code files 4.90 8.65

@ 000191-41 PIC16F84-04/SO 19.90 35.20

@ 000191-42 PIC16F84-04/P 14.70 26.05

#### Sound Pressure Level Meter

@ 020122-1 PCB 19.70 34.85

### No. 313 SEPTEMBER 2002

#### 20-Metres Band Receiver

@ 010097-1 PCB 14.30 25.30

#### Capacitor ESR Tester

@ 012022-1 PCB 16.15 28.60

#### Continuity Tester

@ 020002-1 PCB 4.60 8.10

#### EEDTS Pro Super Loco Decoder Upgrade

@ 020094-41 PIC for super loco decoder 19.90 35.25

@ 020095-41 PIC for return signaller 17.25 30.55

#### Firmware Update for EPROM Emulator

@ 024107-11 Disk, hex file 4.90 8.65

@ 024107-41 AT89C2051-12P, programmed 7.95 14.10

#### High-Speed Controller Board

@ 020102-1 PCB 11.95 21.15

#### Parallel JTAG Interface

@ 020008-1 PCB 8.75 15.45

### No. 312 JULY/AUGUST 2002

#### 4-Bit Decimal Display

@ 024072-31 GAL22V10D-25LP, programmed 6.90 12.20

### No. 321 MAY 2003

#### Countdown Timer

@ 020296-11 Disk, source and hex code 4.90 8.65

@ 020296-41 AT90S1200, programmed 13.90 24.60

#### USB Audio Recorder

@ 012013-11 Disk, EPROM hex code 4.90 8.65

@ 012013-21 EPROM 27C512, programmed 12.60 22.30

#### Valve Final Amp (2)

@ 020071-1 Amplifier board (one channel) 15.10 26.75

@ 020071-2 Power supply board 10.05 17.75

### No. 320 APRIL 2003

#### 8-Channel Disco Light Controller

@ 010131-1 PCB 13.10 23.15

@ 010131-41 87C750 or 87C71, programmed 23.00 40.70

#### Pico PLC

@ 010059-1 PCB 18.70 33.10

@ 010059-11 Disk, test program 4.90 8.65

#### Single-Chip Tone Control

@ 020054-4 PCB 10.90 19.30

#### Switched-Outlet Power Bar with RS232 Control

@ 020298-1 PCB 10.80 19.10

@ 020298-11 Disk, project software 4.90 8.65

#### Temperature Indicator for the PC

@ 020380-11 Disk, source and compiled code 4.90 8.65

@ 020380-41 AT89C2051, programmed 10.25 18.15

### No. 319 MARCH 2003

#### 17 V / 10 A Switch-Mode Power Supply

@ 020054-3 PCB 9.45 16.65

#### Add-on Switch unit for R/C Models

@ 020126-1 PCB 8.95 15.85

@ 020126-11 Disk, hex and source files 4.90 8.65

@ 020126-41 PIC16C712-041/SO, programmed 15.20 26.90

#### AVRee Development System

@ 020351-1 PCB 13.20 23.35

@ 020351-11 Disk, example programs 4.90 8.65

#### Guitar Effects Switchbox

@ 020181-1 PCB 13.15 23.30

#### Intelligent Fan Timer

@ 020170-11 Disk, project software 4.90 8.65

@ 020170-41 MSP430F1121, programmed 11.30 20.00

#### SAA3049 Replacement

@ 020085-1 PCB 13.05 23.10

@ 020085-11 Disk, source and hex code 4.90 8.65

@ 020085-41 87LPC764BN, programmed 9.90 17.55

#### Two-Colour Running Light

@ 010134-1 PCB, controller board 8.25 14.60

@ 010134-2 PCB, LED board 10.65 18.80

@ 010134-11 Disk, project software 4.90 8.65

@ 010134-41 AT89C2051-12PC, programmed 7.15 12.65

### No. 318 FEBRUARY 2003

#### 20/40 MHz Logic Analyser

@ 020032-1 PCB 15.20 26.85

@ 020032-11 Disk, demo program 4.90 8.65

@ 020032-41 AT90S8515-8PC, programmed 15.10 26.70

#### Active Loudspeaker System (2)

@ 020054-2 PCB 7.95 14.05

#### Autoranging Capacitance Meter

@ 020144-1 PCB 7.35 13.00

@ 020144-11 Disk, source and hex files 4.90 8.65

@ 020144-41 PIC16F84A-20/P, programmed 15.20 26.90

#### Dimmer with 0-10 V Control Input

@ 010125-1 control PCB 9.60 17.00

@ 010125-2 dimmer PCB 8.95 15.85

#### Electronic Hourglass

@ 020036-1 PCB 18.55 32.85

@ 020036-11 Disk, project software 4.90 8.65

@ 020036-41 PIC16F84-04/P, programmed 15.20 26.90

Products for older projects (if available) may be found on our web site  
<http://www.elektor-electronics.co.uk>



## ORDERING INSTRUCTIONS, P&P CHARGES

Except in the USA and Canada, all orders, except for subscriptions and past issues (for which see below), must be sent BY POST or FAX to our Tunbridge Wells address using the Order Form overleaf. Please note that we can not deal with PERSONAL CALLERS, as no stock is carried at the editorial and administrative office. On-line ordering: <http://www.elektor-electronics.co.uk>

**Readers in the USA and Canada** may (but are not obliged to) send orders, except for subscriptions (for which see below), to the USA address given on the order form. Please apply to Old Colony Sound for applicable P&P charges. Please allow 4-6 weeks for delivery.

**Orders placed on our Tunbridge Wells office** must include P&P charges (Priority or Standard) as follows:

UK:	£3.50
Europe:	£5.00 (Standard) or £7.00 (Priority)
Outside Europe:	£8.00 (Standard) or £12.00 (Priority)

## HOW TO PAY

Unless you have an approved credit account with us, all orders must be accompanied by the full payment, including postage and packing charges as stated above.

Payment may be made by cheque drawn on a London clearing bank (but see para. 4 below), postal order, VISA, Access, MasterCard or EuroCard (when paying by credit card, the order must go to the cardholder's address). Do not send cash through the mail. Cheques and postal orders should be crossed and made payable to 'Elektor Electronics (Publishing)'.

Payment may also be made by direct transfer from a private or business Giro account to our Giro account No. 34 152 3801 by completing and sending to the National Giro Centre, in a National Giro postage paid envelope, a National Giro transfer/deposit form. Do not send Giro transfers direct to us, as this will delay your order.

If you live outside the UK, payment may also be made by Bankers' sterling draft drawn on a London clearing bank, Eurocheque made out in pounds sterling (with holder's guarantee card number written on the back), or US or Canadian dollar cheque drawn on a US or Canadian bank.

If you pay by Bankers' sterling draft, make clear to the issuing bank that your full name and address MUST be communicated to the London clearing bank.

Our bankers are **NAT WEST PLC, 1 St James's Square, Wadhurst, East Sussex TN5 6BH, England**. Our account number is 3512 5225, Sorting Code 60-22-15.

IBAN code : GB40 NWB K6 022 15 3512 5225

BIC code : NWB KGB 2L

## COMPONENTS

Components for projects appearing in *Elektor Electronics* are usually available from certain advertisers in this magazine. If difficulties in the supply of components are envisaged, a source will normally be advised in the article. Note, however, that the source(s) given is (are) not exclusive.

## TERMS OF BUSINESS

**Delivery** Although every effort will be made to dispatch your order within 2-3 weeks from receipt of your instructions, we can not guarantee this time scale for all orders.

**Returns** Faulty goods or goods sent in error may be returned for replacement or refund, but not before obtaining our consent. All goods returned should be packed securely in a padded bag or box, enclosing a covering letter stating the dispatch note number. If the goods are returned because of a mistake on our part, we will refund the return postage.

**Damaged goods** Claims for damaged goods must be received at our Tunbridge Wells office within 10 days (UK); 14 days (Europe) or 21 days (all other countries).

**Cancelled orders** All cancelled orders will be subject to a 10% handling charge with a minimum charge of £5.00.

**Patents** Patent protection may exist in respect of circuits, devices, components, and so on, described in our books and magazines. Elektor Electronics (Publishing) does not accept responsibility or liability for failing to identify such patent or other protection.

**Copyright** All drawings, photographs, articles, printed circuit boards, programmed integrated circuits, diskettes and software carriers published in our books and magazines (other than in third-party advertisements) are copyright and may not be reproduced or transmitted in any form or by any means, including photocopying and recording, in whole or in part, without the prior permission of Elektor Electronics (Publishing) in writing. Such written permission must also be obtained before any part of these publications is stored in a retrieval system of any nature.

Notwithstanding the above, printed-circuit boards may be produced for private and personal use without prior permission.

**Limitation of liability** Elektor Electronics (Publishing) shall not be liable in contract, tort, or otherwise, for any loss or damage suffered by the purchaser whatsoever or howsoever arising out of, or in connexion with, the supply of goods or services by Elektor Electronics (Publishing) other than to supply goods as described or, at the option of Elektor Electronics (Publishing), to refund the purchaser any money paid in respect of the goods.

**Law** Any question relating to the supply of goods and services by Elektor Electronics (Publishing) shall be determined in all respects by the laws of England.

January 2004

## Subscription rates from January 2004 issue

	Standard	Plus
United Kingdom .....	£39.50	£45.50
<b>Economy Mail</b>		
Rest of the World (excluding Europe) .....	£51.30	£57.30
<b>Priority Airmail</b>		
Europe & Eire .....	£52.50	£58.50
Middle East, Africa, Southwest Asia, Central & South America .....	£64.00	£70.00
Australia, New Zealand, Far East & Pacific Territories .....	£66.00	£72.00
<b>Airfreight</b>		
USA & Canada only .....	US\$88.00	US\$96.50

Payment should be made by:

- Cheque or bankers' draft in sterling drawn on a London clearing bank (except in the USA and Canada — see below); Eurocheques must have the holder's guarantee card number written on the back.
- US\$ cheques drawn on a US or Canadian bank — only by subscribers in the USA or Canada.
- Direct transfer to our bank (NAT WEST PLC, 1 St James's Square, Wadhurst, East Sussex TN5 6BH, England). Our account number is 3512 5225, Sorting Code 60-22-15.
- Postal order.
- Credit card: VISA, ACCESS, Euro/MasterCard, JCB Electron or Switch.
- Transfer to our Giro Account number 34 152 3801. Giro transfers should be

made by completing and sending the appropriate transfer/deposit form to the National Giro Centre (UK) or to your national Giro Centre.

Cheques and postal orders should be made payable to Elektor Electronics (Publishing). Do not send cash through the mail.

## Subscription conditions

The standard subscription order period is twelve months. If a permanent change of address during the subscription period means that copies have to be despatched by a more expensive service, no extra charge will be made. Conversely, no refund will be made, nor expiry date extended, if a change of address allows the use of a cheaper service.

Student applications, which qualify for a 20% (twenty per cent) reduction in current rates, must be supported by evidence of studentship signed by the head of the college, school or university faculty. A standard Student Subscription costs £31.60, a Student Subscription-Plus costs £37.60 (UK only).

Please note that new subscriptions take about four weeks from receipt of order to become effective.

Cancelled subscriptions will be subject to a charge of 25% (twenty-five per cent) of the full subscription price or £7.50, whichever is the higher, plus the cost of any issues already dispatched. Subscriptions cannot be cancelled after they have run for six months or more.

January 2004



**302 Circuits**  
Summer Circuits compilation 1982, 1983, 1984  
£ 10.35/US\$ 21.00

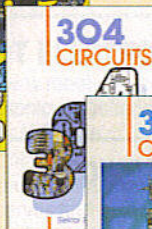

**304 Circuits**  
Summer Circuits compilation 1988, 1989, 1990  
£ 13.45/US\$ 27.00



**305 Circuits**  
Summer Circuits compilation 1991, 1992, 1993  
£ 15.55/US\$ 31.00



**307 Circuits**  
Summer Circuits compilation 1997, 1998, 1999  
£ 18.20/US\$ 37.00



**308 Circuits**  
Summer Circuits compilation 2000, 2001, 2002  
£ 18.20/US\$ 37.00

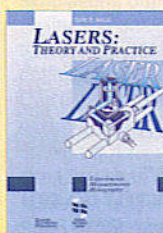

**Lasers: Theory and Practice**  
A valuable book on the practical use of lasers.  
£ 20.75/US\$ 42.00

**Build your own Electronic Test Instruments**

For good reasons (cost, challenge) many researchers, enthusiasts, and experimenters like to build test instruments themselves.  
£ 16.60/US\$ 33.00

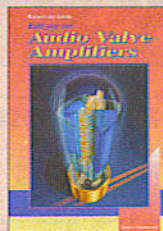

**Build your own Audio Valve Amplifiers**  
This book proves that the thermionic valve is making a come-back.  
£ 15.55/US\$ 31.00

**Designing Audio Circuits**  
How does speech, music, or, indeed, any sound get from the record, CD, or cassette tape to the loud-speaker? This book endeavours to give a comprehensible answer.  
£ 20.75/US\$ 42.00



**Handbook for Sound Technicians**  
A book on the technical aspects of the recording studio.  
£ 20.75/US\$ 42.00



**Build your own High-End Audio Equipment**  
For those who cannot pay high prices for high end equipment, a solution offered in this book: build your own at considerable cost savings.  
£ 15.55/US\$ 31.00

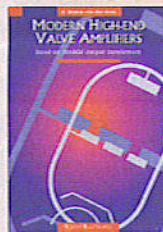

**Modern High-end Valve Amplifiers**  
Valve amplifiers based on toroidal output transformers combine of classical technology and modern components. The result: excellent sonic quality and a revival of the valve amplifier.  
£ 25.95/US\$ 52.00

Microcontrollers

Order now using the Order Form in the Readers Services section in this issue



**Matchbox Basic Computer**  
This book describes a miniature controller system using a programming language called MBL (MatchBox Language), which has its origins in BASIC and Pascal.  
£ 25.95/US\$ 52.00



**ST62 Microcontroller**  
Practical programming of the ST62 series of microcontrollers from SGS Thomson.  
£ 24.95/US\$ 50.00



**PICs in Practice**  
The PIC16C5x family is a series of microcontrollers that lend themselves to a broad variety of applications.  
£ 24.95/US\$ 50.00



**Short Course 8051/8032 Microcontrollers**  
A course describing the hardware and software (assembler code) to make a complete micro-controller system based on an MCS-51 controller.  
£ 9.95/US\$ 20.00

Computers

See also [www.elektor-electronics.co.uk](http://www.elektor-electronics.co.uk)



**Dictionary of Monitor Technology**  
A pioneering book of unsurpassed range which clearly documents all aspects of the development of computer monitors.  
£ 25.95/US\$ 52.00



**Faultfinding in Computers and Digital Circuits**  
This book covers faultfinding not just in microprocessor systems, microcontrollers and industrial PCs, but also in consumer items such as personal computers, multimedia devices, digital television and so on.  
£ 31.15/US\$ 63.00



**The I2C Bus**  
This book deals extensively with the technical specifications of the I2C bus.  
£ 25.95/US\$ 52.00



**PC Service and Repair**  
This book provides the information you need to be able to deal with computer system faults whenever they occur.  
£ 31.15/US\$ 63.00



**SCSI THE INS AND OUTS**  
This book comes with a CD-ROM and will prove invaluable when you want to sort out a problem in a SCSI system.  
£ 24.95/US\$ 50.00



**PC Interfaces under Windows**  
Measurement and control using standard ports PC Interfaces can be used for more than just the printer, mouse, modem and joystick!  
£ 25.95/US\$ 52.00

# NET LINKS

To book your website space contact **Bernard Hubbard**

Tel 00 44 (0)1242 510760 Fax: 0044 (0)1242 226626

## BETA LAYOUT

[www.pcb-pool.com](http://www.pcb-pool.com)

Beta layout Ltd Award-winning site in both English and German offers prototype PCBs at a fraction of the cost of the usual manufacturers' prices.



## BURN TECHNOLOGY LTD

<http://www.burntec.com>

Distributors of a wide range of device programmers, package adaptors, test and soldering equipment. Order online and get free delivery on all orders over £30.00.

## COMPUCUT

<http://www.compucutters.com>

Computer Numerical Control from your home PC. Great for tricky jobs, and accurate repetitive work. We supply: - Software - Interface - Manual - Support  
Price £250 plus postage.

## CONFORD ELECTRONICS

<http://www.confordelec.co.uk>

Lightweight portable battery/mains audio units offering the highest technical performance. Microphone, Phantom Power and Headphone Amplifiers. Balanced/unbalanced signal lines with extensive RFI protection.

## CROWNHILL ASSOCIATES LTD

<http://www.crownhill.co.uk>

tel 01353 666709 fax 01353 666710

- Manufacturers of production quality device programmers
- PIC Programmers
- PIC Development tools
- Manufacturers of Smart Cards
- Smart Card Programmers
- Design & Development Services

Crownhill Associates Limited

32 Broad Street Ely, Cambridge CB7 4AH  
Tel: 01353 666709 Fax: 01353 666710



## DANBURY ELECTRONICS

<http://www.mc-h.demon.co.uk/transformers.html>

Here you will find our mains and output transformers in Mike Holme's range of valve/tube amplifiers (PP & SE). Also circuits, parts lists, chassis, advice.

## DEBUG INNOVATIONS UK

<http://www.debuginnovations.com>

Introducing hassle free prototyping

- RF / Analogue
- High speed digital
- Surface mount
- 0.1" grid
- Power planes
- Unique patch architecture

Forget custom PCBs, start your project now!



## EASYSYNC

<http://www.easysync.co.uk>

EasySync Ltd sells a wide range of single and multi-port USB to RS232/RS422 and RS485 converters at competitive prices.



## ELM ELECTRONICS

<http://www.elmelectronics.com>

Offering a variety of unique and low cost integrated circuits for the experimenter. Secure ordering via the web site with worldwide shipping.

## ELNEC

[www.elnec.com](http://www.elnec.com)

- device programmer manufacturer
- selling through contracted distributors all over the world
- universal and dedicated device programmers
- excellent support and after sale support
- free SW updates
- once a months new SW release
- reliable HW
- three years warranty for most programmers



## ERVAN INTERNATIONAL Co.

<http://www.ervan-int.com>

Power Electronics and Solar Energy Design and Consultants. Also offers;

- Discount prices of:
- Ultra Bright LEDs
  - PCB LED Cluster Kits
  - Laser Pointers
  - Solar Modules
  - Batteries

## FOREST ELECTRONIC DEVELOPMENT

<http://www.fored.co.uk>

FED supply PIC programmers, Basic modules, and development software including a PIC C Compiler, Prog 'n Drop Visual Development and a well featured debugging environment.

## FUTURLEC

<http://www.futurlec.com>

Save up to 60% on

- Electronic Components
- Microcontrollers, PIC, Atmel
- Development Boards, Programmers

Huge range of products available on-line for immediate delivery, at very competitive prices.

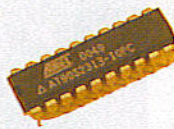

## FUTURE TECHNOLOGY DEVICES

<http://www.ftdichip.com>

FTDI designs and sells USB-UART and USB-FIFO interface i.c.'s.

Complete with PC drivers, these devices simplify the task of designing or upgrading peripherals to USB

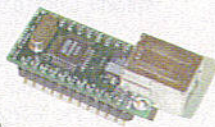

## HAMMOND ELECTRONICS

<http://www.hammondmfg.com>,

[sales@hammond-electronics.co.uk](mailto:sales@hammond-electronics.co.uk)

tel: 01256 812812.  
Small die-cast, plastic and metal enclosures for the hobbyist and professional. Widely available from major distributors.



## MQP ELECTRONICS

<http://www.mqpelectronics.co.uk>

Leaders in Device Programming Solutions.

- Online shop
- Low Cost Adapters for all Programmers
- Single Site and Gang Programmers
- Support for virtually any Programmable Device



## NEW WAVE CONCEPTS

<http://www.new-wave-concepts.com>

Software for hobbyists:

- Livewire circuit simulation software, only £29.36
  - PCB Wizard circuit design software, only £29.36
- Available from all Maplin Electronics stores and [www.maplin.co.uk](http://www.maplin.co.uk)



## PICBASIC

<http://www.picbasic.co.uk>

- Pic basic & Pic Basic Pro
- Fast efficient powerful compilers
- Parallax stamp compatible code
- Write in basic-compile to hex
- 12c, 14c, 16c(f) and 17c pic's



## POND ELECTRONICS

<http://www.pond.ie>

tel +353-1-821-5060

fax +353-1-820-9384

Innovative systems for PIC development & embedded applications.

- µFlash876
- PIC C Compilers & Programmers
- MicroStack • Basic Stamp
- Custom development Service



## QUASAR ELECTRONICS

[www.QuasarElectronics.com](http://www.QuasarElectronics.com)

Over 300 electronic kits, projects and ready built units for hobby, education and industrial applications including PIC/ATMEL programming solutions. Online ordering facilities.

Tel: +44 (0) 870 246 1826

Fax: +44 (0) 870 460 1045

Email: [sales@QuasarElectronics.com](mailto:sales@QuasarElectronics.com)





## ROBOT ELECTRONICS

<http://www.robot-electronics.co.uk>

- Ultrasonic rangefinders
- Motor H-Bridge controllers
- Magnetic Compasses
- RC servos and controllers
- PIC programmers and components
- Electronic Design/Development and Manufacturer to industry



## SPICEAGE AND SPICYCLE

<http://www.spiceage.com>

Spicycle circuit design program (schematic drawing, well-featured PCB drawing, SpiceAge simulation). SuperFilter digital and analogue filter synthesis and optimisation.



*The World is getting onto Spicycle*

Download a free working evaluation and enjoy software renowned for its high quality at prices that make it seem like Christmas all year round.

Make contact with Those Engineers (020 8906 0155), real engineers, who will understand your needs.

## TECHNOBOTS

<http://www.technobots.co.uk>

Welcome to Technobots - the one stop shop especially for the remote operated robot builder, radio control and engineering hobbyist.



## TELNET

<http://www.telnet.uk.com>

The site shows graphically Telnets wide range of quality second-user test and measurement equipment, including oscilloscopes and spectrum analysers.



## ULTRALEDs

<http://www.ultraleds.co.uk>

tel: 0871 7110413

Large range of low cost Ultra bright leds and Led related lighting products. Major credit cards taken online with same day depatch.

## USB INSTRUMENTS

<http://www.usb-instruments.com>

USB Instruments specialises in PC based instrumentation products and software such as Oscilloscopes, Data Loggers, Logic Analysers which interface to your PC via USB.



## VIEWCOM

<http://www.viewcom.f9.co.uk>

tel: 020 8471 9338 fax: 020 8552 0946

- Mail Order supplier of:
  - Integrated Circuits and Components.
  - Kit and parts for Elektor projects.
  - Transistors, FETs, Capacitors, Resistors, Crystals, etc and hard to find devices.
- Viewcom Electronics, 77 Upperton Road West, Plaistow, London E13 9LT

# PROMOTE YOUR WEBSITE HERE

Elektor Electronics have a feature to help customers to promote their websites, Net Links - a permanent feature of the magazine where you will be able to highlight your site on a regular basis.

- For just £120 + VAT (£10.90 per issue for eleven issues) Elektor will publish your company name, a 25-word description and your website address.
- For £300 + VAT for the year (£27.27 per issue for eleven issues) we will publish the above plus run a 3cm deep full colour screen shot from your site.

Places are limited and spaces will go on a strictly first come, first served basis, please fax back your order today!

I wish to promote my company, please book my space:

- Text insertion only for £120 + VAT
- Text and photo for £300 + VAT

NAME:..... ORGANISATION:.....

JOB TITLE:.....

ADDRESS:.....

..... TEL:.....

PLEASE COMPLETE COUPON BELOW AND FAX BACK TO 00-44-(0)1242 226626

COMPANY NAME.....

WEB ADDRESS.....

25-WORD DESCRIPTION.....

.....

.....

.....

.....

# ELECTRONIC ENTHUSIASTS

Only one magazine tests its projects and circuits in its own lab before publication -

## ELEKTOR ELECTRONICS

THE ELECTRONICS & COMPUTER MAGAZINE

**SUBSCRIBE TODAY!**

Contact: Worldwide Subscription Service Ltd, Unit 4 Gibbs Reed Farm, Pashley Road, Ticehurst TN5 7HE Telephone: (+44) (0) 1580 200657 Fax: (+44) (0) 1580 200616  
Or visit our Website: [www.elektor-electronics.co.uk](http://www.elektor-electronics.co.uk)

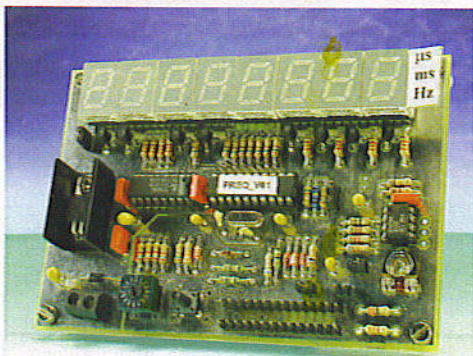

### MULTI-FUNCTION FREQUENCY METER

The simple construction of this instrument belies its power, versatility and ease of use. At the heart of the circuit we find an AT90S2013 microcontroller running software for a plethora of functions, including

- Pulse duration of positive or negative half cycles, in microseconds and milliseconds
- Period, in microseconds and milliseconds
- Frequency, using gate times of 0.1 s, 1.0 s and 10.0 s
- Event counter (7 digits)
- Stopwatch with 0.01 s resolution

### DRM RECEIVER

Theory is fine as long as it is followed by a practical application. After our introductory article on Digital Radio Mondiale (DRM) in the December 2002 issue and the Experimental DRM Receiver in the December 2003 issue, we now follow suit and embark on a full-blown construction project. Our DRM Receiver is tuned over an RS232 interface and supplies an MPEG-4 output signal for decoding by your PC soundcard. The circuit is simple and inexpensive, yet guarantees digital quality from short-wave broadcasts.

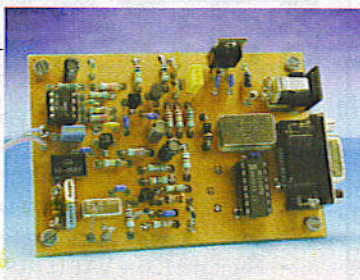

### ALSO...

- Wind Power, Hands-On CPLDs (2), Failsafe for RC Models, Code Lock, Bistable Relay Driver, BASCOM AVR for CF Cards, IR Servo Motor Interface for RCX.

### RESERVE YOUR COPY NOW!

The March 2004 issue goes on sale on Friday 24 February 2004 (UK distribution only). UK subscribers will receive the magazine a few days before this date. Article titles and magazine contents subject to change.

## NEWSAGENTS ORDER FORM

### SHOP SAVE / HOME DELIVERY

Please save / deliver one copy of *Elektor Electronics* magazine for me each month

Name: .....

Address: .....

Post code: .....

Telephone: .....

Date: .....

Signature: .....



Please cut out or photocopy this form, complete details and hand to your newsagent. *Elektor Electronics* is published on the third Friday of each month, except in July. Distribution S.O.R. by Seymour (NS).

### INDEX OF ADVERTISERS

Beta Layout, Net Links	<a href="http://www.pcb-pool.com">www.pcb-pool.com</a>	63, 72	MQP Electronics, Net Links	<a href="http://www.mqpelectronics.co.uk">www.mqpelectronics.co.uk</a>	72
Burn Technology LTD, Net Links	<a href="http://www.burntec.com">www.burntec.com</a>	72	Net Links		72, 73
CMS	<a href="http://www.cms.uk.com">www.cms.uk.com</a>	7	New Wave Concepts, Net Links	<a href="http://www.new-wave-concepts.com">www.new-wave-concepts.com</a>	72
Compucut, Net Links	<a href="http://www.compucutters.com">www.compucutters.com</a>	72	Number One Systems	<a href="http://www.numberone.com">www.numberone.com</a>	62
Conford Electronics, Net Links	<a href="http://www.confordelec.co.uk">www.confordelec.co.uk</a>	72	PAGM	<a href="http://www.pagm.co.uk">www.pagm.co.uk</a>	2
Cricklewood		29	PCB shop	<a href="http://www.thepcbshop.com">www.thepcbshop.com</a>	68
Crownhill, Net Links	<a href="http://www.crownhill.co.uk">www.crownhill.co.uk</a>	72	Picbasic, Net Links	<a href="http://www.picbasic.co.uk">www.picbasic.co.uk</a>	72
Danbury, Net Links	<a href="http://www.mc-h.demon.co.uk">www.mc-h.demon.co.uk</a>	60, 72	Pico	<a href="http://www.drdaq.com">www.drdaq.com</a>	6
Debug Innovations, Net Links	<a href="http://www.debuginnovations.com">www.debuginnovations.com</a>	72	Pond Electronics, Net Links	<a href="http://www.pond.ie">www.pond.ie</a>	72
Display Electronics	<a href="http://www.distel.co.uk">www.distel.co.uk</a>	23	Quasar Electronics, Net Links	<a href="http://www.quasarelectronics.com">www.quasarelectronics.com</a>	61, 72
Easysync, Net Links	<a href="http://www.easysync.co.uk">www.easysync.co.uk</a>	72	Robot Electronics, Net Links	<a href="http://www.robot-electronics.co.uk">www.robot-electronics.co.uk</a>	73
ELM Electronics Net Links,	<a href="http://www.elmelectronics.com">www.elmelectronics.com</a>	72	Spiceage and Spicycle, Net Links	<a href="http://www.spiceage.com">www.spiceage.com</a>	73
Eltec, Net Links	<a href="http://www.eltec.com">www.eltec.com</a>	72	Stewart of Reading	<a href="http://www.stewart-of-reading.co.uk">www.stewart-of-reading.co.uk</a>	29
Ennovi	<a href="http://www.ennovi.co.uk">www.ennovi.co.uk</a>	60	Technobots, Net Links	<a href="http://www.technobots.co.uk">www.technobots.co.uk</a>	73
Ervan, Net Links	<a href="http://www.ervan-int.com">www.ervan-int.com</a>	72	Telnet, Net Links	<a href="http://www.telnet.uk.com">www.telnet.uk.com</a>	73
Forest, Net Links	<a href="http://www.fored.co.uk">www.fored.co.uk</a>	8, 80	Ultraleds, Net Links	<a href="http://www.ultraleds.co.uk">www.ultraleds.co.uk</a>	73
Futurlec, Net Links	<a href="http://www.futurlec.com">www.futurlec.com</a>	72	USB Instruments, Net Links	<a href="http://www.usb-instruments.com">www.usb-instruments.com</a>	73
Future Technology Devices, Net Links	<a href="http://www.ftdichip.com">www.ftdichip.com</a>	72	Viewcom, Net Links	<a href="http://www.viewcom.f9.co.uk">www.viewcom.f9.co.uk</a>	73
Hammond Electronics, Net Links	<a href="http://www.hammondmg.com">www.hammondmg.com</a>	72			
ITP	<a href="http://www.itp101.com">www.itp101.com</a>	55			
Kit Radio Company	<a href="http://hometown.aol.co.uk/kitradioco/uk.htm">hometown.aol.co.uk/kitradioco/uk.htm</a>	63			
Labcenter	<a href="http://www.labcenter.co.uk">www.labcenter.co.uk</a>	76			
LPRS	<a href="http://www.lprs.co.uk">www.lprs.co.uk</a>	75			
Matrix Multimedia Ltd	<a href="http://www.matrixmultimedia.co.uk">www.matrixmultimedia.co.uk</a>	7			
Milford Instruments	<a href="http://www.milinst.demon.co.uk">www.milinst.demon.co.uk</a>	10			

ADVERTISING SPACE for the issue of 23 March 2004 may be reserved not later than 25 February 2004 with Elektor Electronics (Publishing) Advertisement Office - 3 Crescent Terrace - Cheltenham GL50 3PE - England - Telephone 01242 510 760 - Fax 01242 226 626 - e-mail: [bernardhubbard@ukonline.co.uk](mailto:bernardhubbard@ukonline.co.uk) to whom all correspondence, copy instructions and artwork should be addressed.

## "easy-Radio". Setting the new standard in short range radio software solutions.

Easy Radio is a simple, off-the-shelf solution to getting radio control and communication products to market – fast. Experience has shown that less than 5% of customers who have a genuine need for a wireless solution actually succeed in putting a product on the market!

### Why?

Writing software for a "piece of wire" is one thing, doing the same with no wire present simply doesn't work. There are many, many problems to overcome the first time this exercise is undertaken and there may be little time to acquire this new skill.

In response to this problem LPRS has created a protocol which will take care of all the communications requirements of the "link" – we called it – **EASY RADIO!**

The software takes care of Tx encoding and Rx decoding as well as RS232, TTL or whatever standard data the user wishes to input. A true data-in – data-out, result is achieved. In the case of transceivers data is buffered on chip and retries are programmed in. It is in transceiver applications that the software really comes into its own as two-way wireless communication is particularly difficult to achieve – reliably.

The "easy-Radio" software converts inputted data into what we refer to as an "efficient over air format" which results in less missed data and extended range.

*LPRS will also customize the software to meet your specific needs, often FREE of charge!*

**e a s y**  
**radio**

The software is available with most of our range of modules in particular our NEW ER400/900 "S" series of Tx, Rx and Txcvrs. These not only have the ER protocol already embedded but also offer the user unparalleled flexibility in choosing:

- Power output levels
- Data rate
- and most useful – frequency selection

[www.easy-Radio.com/uk](http://www.easy-Radio.com/uk)

## Radio transceiver takes protocols onboard for two-way stress-less wireless

The ER400TRS is an extremely compact licence-exempt intelligent radio transceiver module designed to make best use of the company's innovative Easy-Radio technology. The UK designed and manufactured device houses a complete transmitter and receiver system with all communications protocols embedded in onboard memory to allow OEMs to add wireless capabilities to their products without the need to understand radio technology. The modules are compliant with EN300-220-3 and EN301489-3 for unlicensed use in the pan-European 433-434MHz band. All of this comes in a tiny 9-pin single-inline package which is smaller than most conventional receivers.

The new transceiver will suit any wireless application that requires two-way data or

where it is essential that a receiving node issues a "receipt" to confirm reception of transmitted data. These include equipment such as remote data acquisition systems, handheld terminals and electronic point of sale terminals.

The ER400TRS transceiver is supplied "ready-to-run out-of-the-box" from LPRS. Alternatively, designers can make use of a range of user-programmable functions to customise their radio links to their own specifications using simple software commands. The datarate of the link defaults to the industry standard of 19.2Kbit/s, but can be programmed to any rate between 4.8 and 76.8Kbit/s. A line-of-site range of 250m is easily attainable. All encoding and decoding functions are also handled onboard.

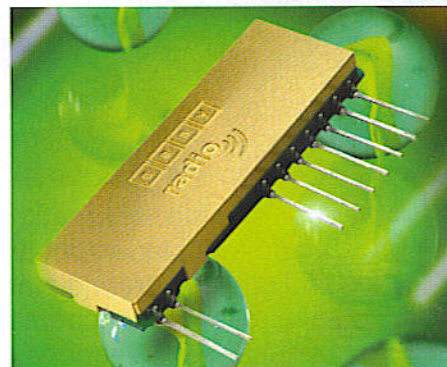

The transmitter power output is also programmable up to the legal maximum ERP of 10mW, using a standard 50ohm antenna type, such as a whip, helical or PCB loop.

[www.lprs.co.uk/1](http://www.lprs.co.uk/1)

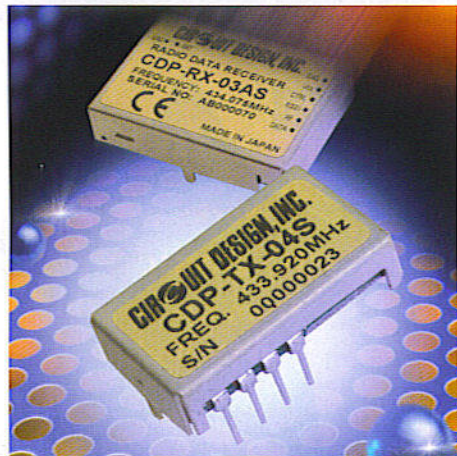

## Easy Radio cuts through the noise to get to market fast

Developed for applications where reliable radio communication in noisy RF environments is essential the CDPTX4-4(8)-ER transmitter and CDPRX3-4(8)-ER receiver offer a high performance, narrow band, FM radio link and operate in the 433-4MHz or 868-870MHz unlicensed bands for Europe. Both parts feature embedded "Easy-Radio" software protocols eliminating the need to write complex radio software and able to accept customer's data in a number of standard forms.

By providing an instant radio link no specialist RF knowledge is required and

(end) system time to market is minimised. By using narrow band transmission operating range is typically 1Km in external applications and 150m in internal. The units operate from a supply voltage between 3-5VDC and require less than 25mA of power. Data transfer rate is 4,800 bps and for orders over 100pcs customised operating software can be provided, often free of charge.

Typical applications would be remote control systems where speed to market is valued and where signal integrity is essential.

[www.lprs.co.uk/2](http://www.lprs.co.uk/2)

# PROTEUS

**The Complete Electronics Design System**

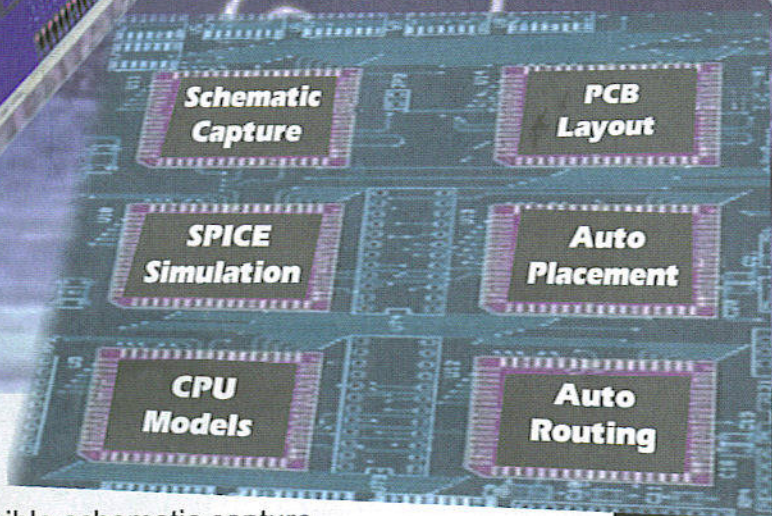
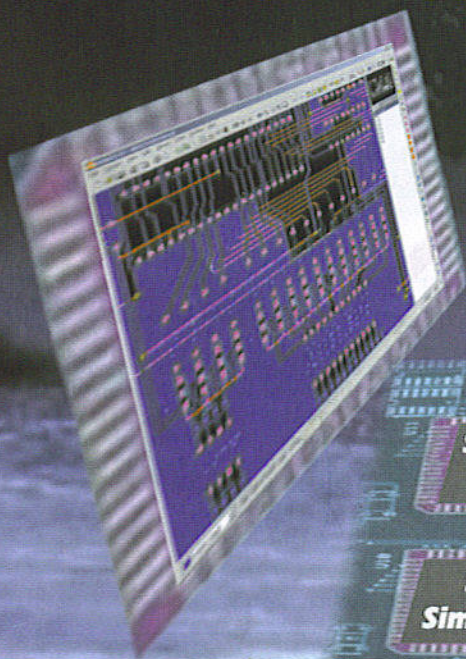

## VSM

Virtual System Modelling

### Schematic & PCB Layout

- Powerful & flexible schematic capture.
- Auto-component placement and rip-up/retry PCB routing.
- Polygonal gridless ground planes.
- Libraries of over 8000 schematic and 1000 PCB parts.
- Bill of materials, DRC reports and much more.

### Mixed Mode SPICE Circuit Simulation

- Berkeley SPICE3F5 simulator with custom extensions for true mixed mode and interactive simulation.
- 6 virtual instruments and 14 graph based analysis types.
- 6000 models including TTL, CMOS and PLD digital parts.
- Fully compatible with manufacturers' SPICE models.

### Proteus VSM - Co-simulation and debugging for popular Micro-controllers

- Supports PIC, AVR, 8051, HC11 and ARM micro-controllers.
- Co-simulate target firmware with your hardware design.
- Includes interactive peripheral models for LED and LCD displays, switches, keypads, virtual terminal and much, much more.
- Provides source level debugging for popular compilers and assemblers from Crownhill, IAR, Keil, and others.

## New Features in Version 6

- Drag and drop toolbars.
- Visual PCB packaging tool.
- Improved route editing.
- Point and click DRC report.
- Multiple design rules (per net).
- Multiple undo/redo.

**Call Now for Upgrade Pricing**

Works with  
**PIC Basic Plus**  
from Crownhill  
Associates

labcenter

Electronics  
53-55 Main Street, Grassington. BD23 5AA

Tel: 01756 753440  
Fax: 01756 752857

Contact us for  
**Free Demo CD**

[www.labcenter.co.uk](http://www.labcenter.co.uk)  
[info@labcenter.co.uk](mailto:info@labcenter.co.uk)